

Smart Workflow **x** High Productivity
Network Storage and Computing System

TS-x53B Series

2 / 4 / 6-bay NAS

Equipped with One PCIe Expansion Slot Unlimited Possibilities

QM2 M.2 SSD / 10GbE Network Expansion Card

- Supports SSD caching and Qtier, a high-efficiency auto-tiering storage system

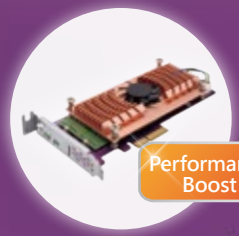

Performance Boost

Dual-port USB 3.1 Gen2 10Gbps Type-A Expansion Card

- Enables lightning-fast transmission. Compatible with USB 3.0 and 2.0 devices.



Dual-band 2.4 GHz/5 GHz PCI Express Network Expansion Card

- Turns your NAS into a wireless base station, allowing devices to quickly access NAS resources using Wi-Fi



TS-653B

- ◆ USB Type-C QuickAccess port for accessing files without needing a network connection.
- ◆ Equipped with quad-core Intel® Celeron® J3455 processor, burst up to 2.41 GHz.
- ◆ Supports AES-NI encryption and accelerated video decoding and transcoding.
- ◆ A hybrid approach to virtualization: Virtualization Station, Linux Station, and Container Station, with remote access support.
- ◆ QTS 4.3 provides File Station for managing files and data, QmailAgent as a centralized email manager, and Qcontact for storing contact information.
- ◆ Features an OLED screen, touch-sensitive buttons, speaker with verbal system warnings, and easy-to-access internals with tool-less hard drive installation.



QNAP's first smart workflow process based computing and storage system

TS-x53B NAS series is equipped with QTS 4.3 operating system to create the first smart workflow-oriented file storage system (Workflow Based NAS OS). Using file management application File Station as the core, it provides convenient remote mount function, so that you can manage local NAS, external devices, remote NAS and cloud files within a single interface. Various tools such as Notes Station, QmailAgent and Qcontactz make collaborative notes, e-mail and contact management super convenient, so you can focus on work without missing any important information. With Qsirch full-text search, you can search for the exact file you want by just entering the keywords. Other features such as the Qsirch full-text search engine and Qfiling's automatic archiving feature greatly assist in daily NAS management tasks.

In addition, TS-x53B also provides other rich business applications such as cross-platform data storage and disaster recovery, Volume / LUN snapshot backup and virtualization storage, and it's also equipped with PCIe expansion slots, so it can be used as 10GbE network, M.2 SSD cache and USB 3.1 10Gbps expansion. It also has built-in high availability USB Type-C QuickAccess port and standard SD memory card slot, so that large file transmission and sharing is made more convenient. TS-x53B also supports 4K (H.264) video instant playback and transfer, so it can act as a high-quality platform for media workers to work together.

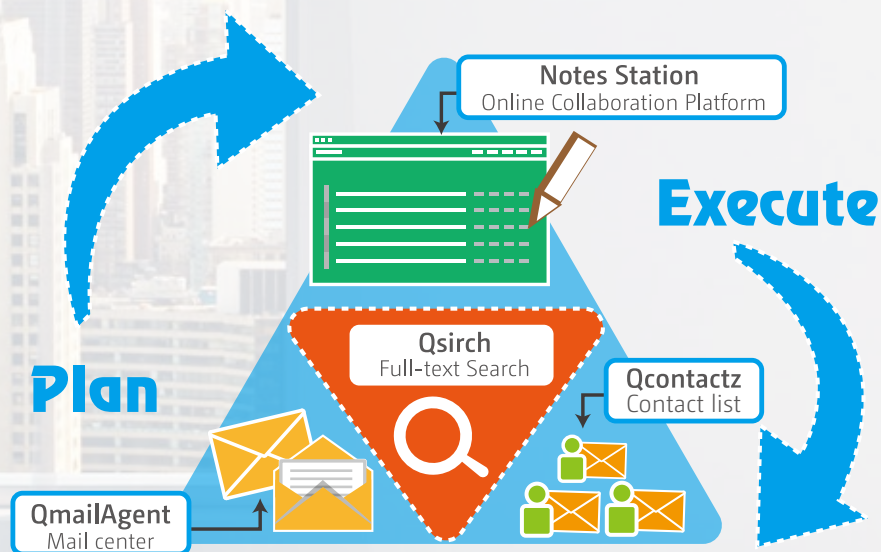

- 01 TS-x53B Series Hardware Overview
- 05 Multimedia collection center
- 13 Smart workflow
- 37 Backup & storage space management
- 53 File synchronization and remote access
- 57 QTS 4.3 NAS Operating System
- 62 Network management and setup
- 70 Virtualization Application & QvPC Technology
- 79 QIoT applications
- 81 Video Surveillance Solution
- 88 Multi - NAS bonus applications
- 89 Application tools
- 91 Mobile App



TS-x53B

Network Storage and Computing Device

Small in size
Big in features

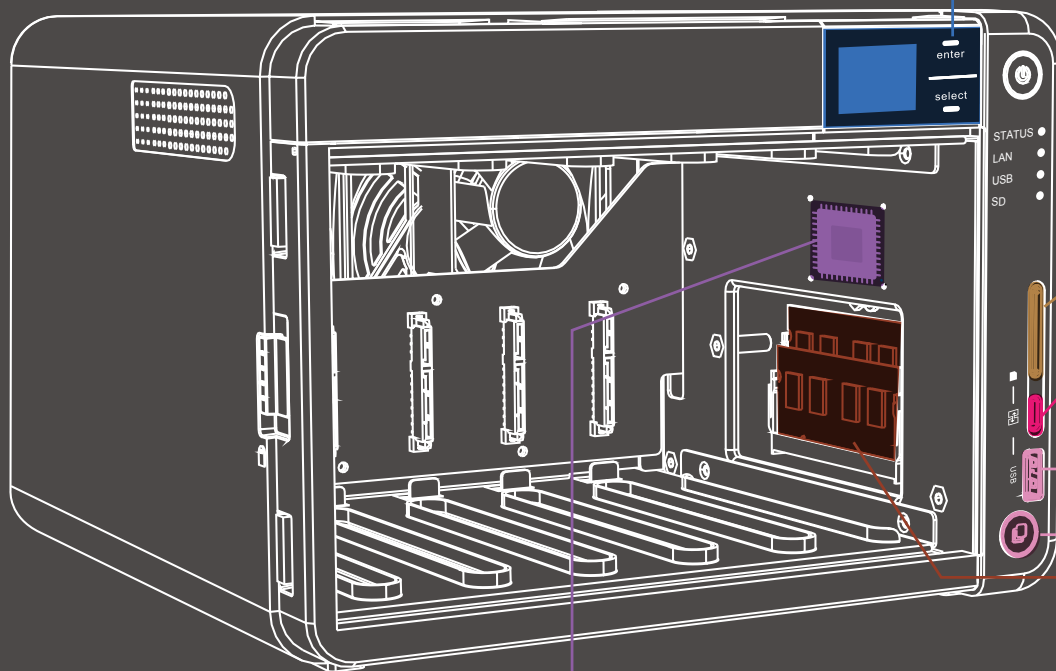

01 High definition screen and sensitive buttons
- System status at a glance

02 SD card slot
- Easily back up your photos

03 USB-C Quick Access
plug and play
- Connect to Windows PC via the USB-C Quick Access
NAS front panel without
through complicated network
Find your NAS in Qfinder
install and access the data

04 USB 3.0 ports
One Touch Copy
- Press the "Copy" button
your data

05 Up to 8GB
DDR3L memory
- 2 x SODIMM memory slots

06 Front cover with magnets and lock
- Quick disassembly and dust prevention

07 Quad-core Intel® Celeron® J3455
1.5 GHz processor, burst up to 2.3 GHz

- 9th-generation HD Graphics processor and 4K hardware-accelerated video transcoding engine
- AES-NI encryption engine

Expansion card installation

1

2

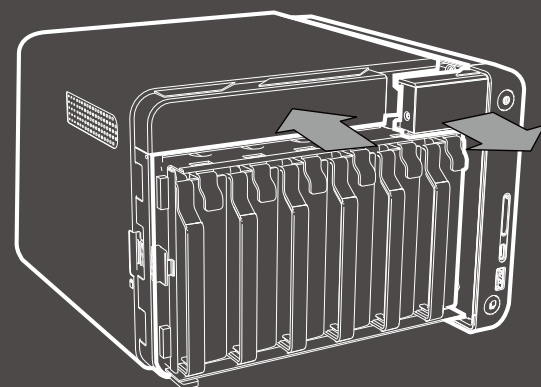
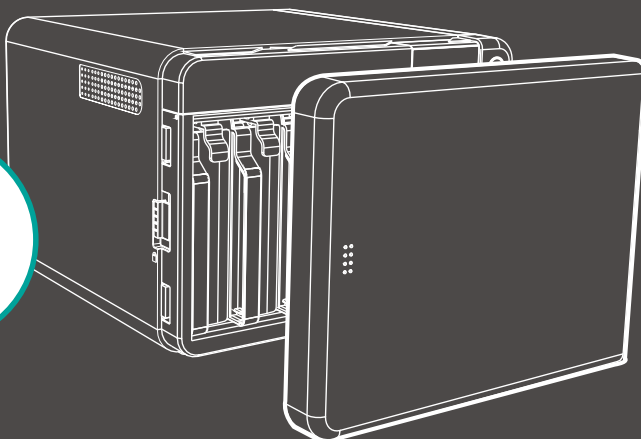
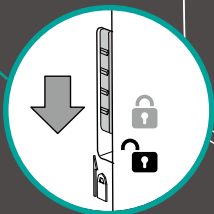

tion OLED
touch-
buttons

nce
t
photos

ckAccess,
ay

PCs and Macs directly
Access Port on the
ut having to go
network configurations.
der Pro, and easily
NAS shared folder.

rt and USB
Copy button

on to quickly back up

emory

slots

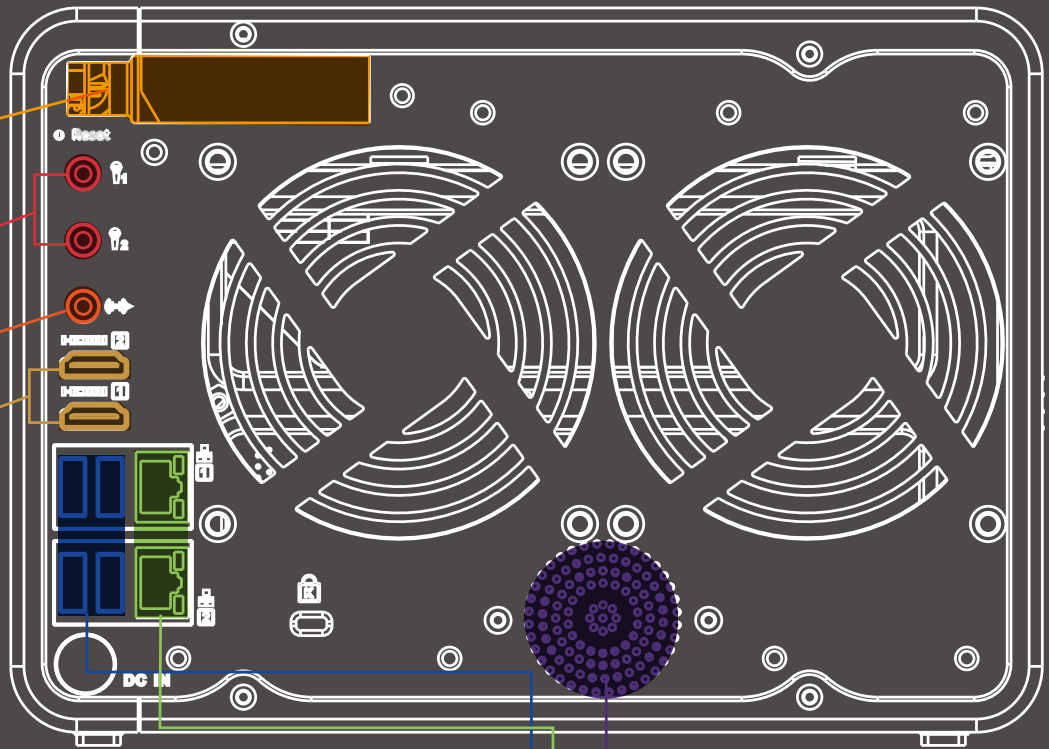

08 1 x PCIe expansion slot

- PCIe 2.0 x2. Can install QM2 M.2 SSD/10GbE expansion card, 10GbE network expansion card, USB 3.1 expansion card, and wireless expansion card

09 2 x 3.5 mm microphones jacks

- Supports dynamic microphones

10 3.5 mm line-out jack

- Can directly play music files on the NAS by connecting to external speakers

11 2 x 4K HDMI ports

- HDMI v1.4b support up to 3840 x 2160
- Supports mirroring or extended desktop output

12 Built-in speaker

- Music playback
- Verbal system warnings

13 4 x USB 3.0 ports

- Supports external hard drives, printers, and UPS

14 2 x Gigabit network ports

- Provide load balancing and other port-trunking network mode

3

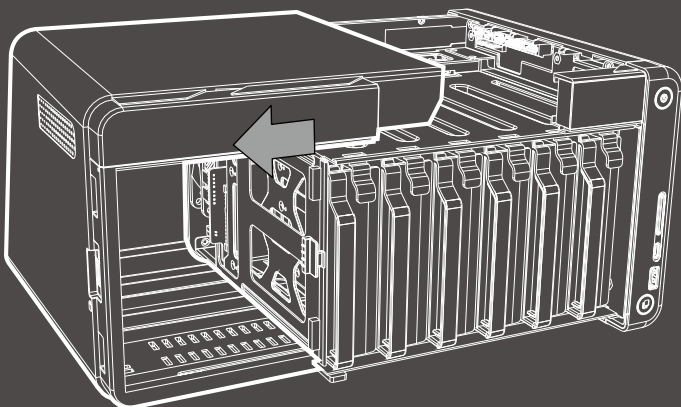

Supports 3.5-inch hard drive tool-free installation

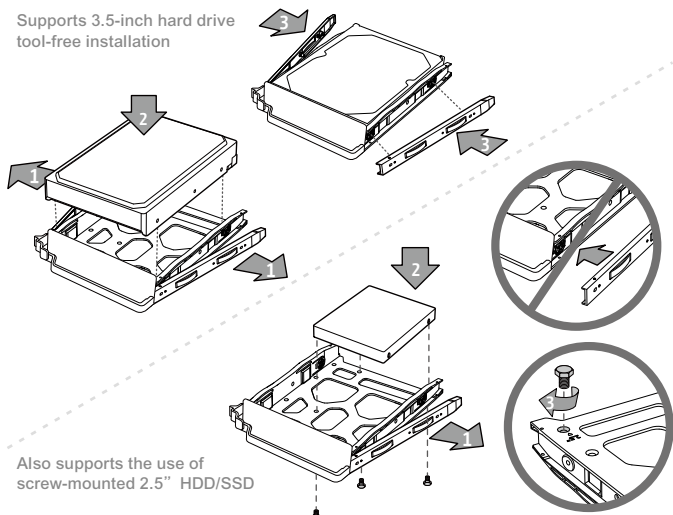

Also supports the use of screw-mounted 2.5" HDD/SSD

Next-generation computing and storage system

TS-x53B Series Hardware Overview

Redefine your private cloud

QTS-Linux dual-system NAS

Intel® Celeron® J3455 quad-core 1.5 GHz processor with AES-NI encryption acceleration

The TS-x53B is equipped with the latest 14-nm Intel® Celeron® J3455 quad-core 1.5 GHz (burst up to 2.3 GHz) processor and 4GB/8GB DDR3L dual channel RAM (expandable to 8GB) with 2 build-in 1GbE network ports. It supports SATA 6Gb/s and provides up to 225 MB/s continuous read/write performance for running tasks quickly and smoothly. The TS-x53B has a built-in Intel® AES-NI next-generation encryption engine (using AES 256-bit encryption) for whole-NAS or folder encryption and can maintain up to 225 MB/s data read/write speeds, so it can protect sensitive information on the NAS while maintaining high performance.

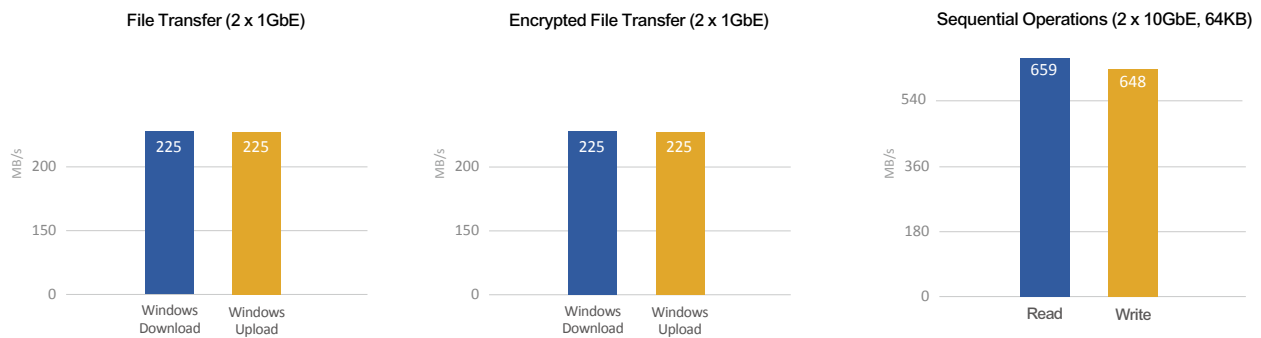

Tested in QNAP laboratories. Data may vary due to differences in physical environments.

Test environment:

NAS: TS-453B

OS: QTS 4.3.3

Disk group: RAID 5; 4 x Intel S3500 240GB SSDs (SSDSC2BB240G4); Equipped with QNAP LAN-10G2SF-MLX 2 ports 10GbE SFP + NIC

Client Computer:

Intel® Core™ i7-4770 3.40GHz CPU; DDR3L 1600Hz 16GB; WD 1TB WD10EZEEX;

Intel Gigabit CT (MTU 1500) ; Windows® 10 64-bit

PCIe expansion for multiple storage applications

The TS-x53B has a PCIe expansion slot, allowing you to flexibly configure multiple applications as needed. You can install a QNAP QM2 M.2 SSD / 10GbE PCIe dual-port card for adding an M.2 SSD cache or 10GbE connectivity, or a compatible wireless network card to add wireless base station functionality to the TS-x53B, or a USB 3.1 10Gbps card to expand connectivity options.

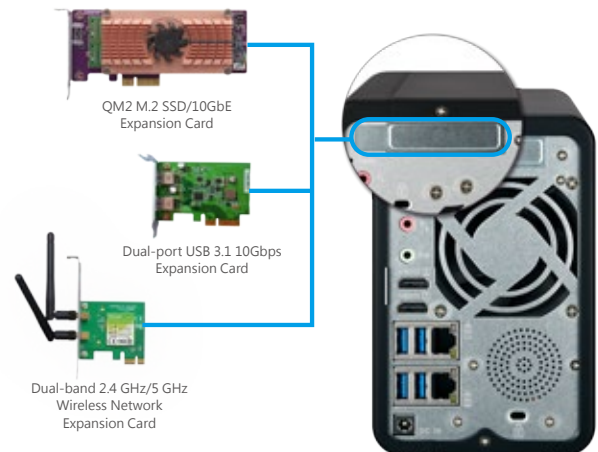

QM2 M.2 SSD / 10GbE PCIe expansion card: NAS performance and application upgrade

The QM2 PCIe expansion card series adds M.2 SSD and 10GbE connectivity* to the TS-x53B, enabling greater NAS performance and compatibility with 10GbE networks. Two M.2 22110 or M.2 2280 SSDs (in RAID 1 or RAID 0) can be added to the QM2 expansion card for caching or tiering. QM2 not only significantly enhances overall performance of NAS, but allows affordable connectivity to 10GbE networks.

** QM2-2S, QM2-2P: Compatible with QTS 4.3.3 (or later). QM2-2S10G1T, QM2-2P10G1T: Compatible with QTS 4.3.4 (or later).

* 10GbE connectivity is only provided by the QM2-2S10G1T and QM2-2P10G1T.

Hardware Design Analysis

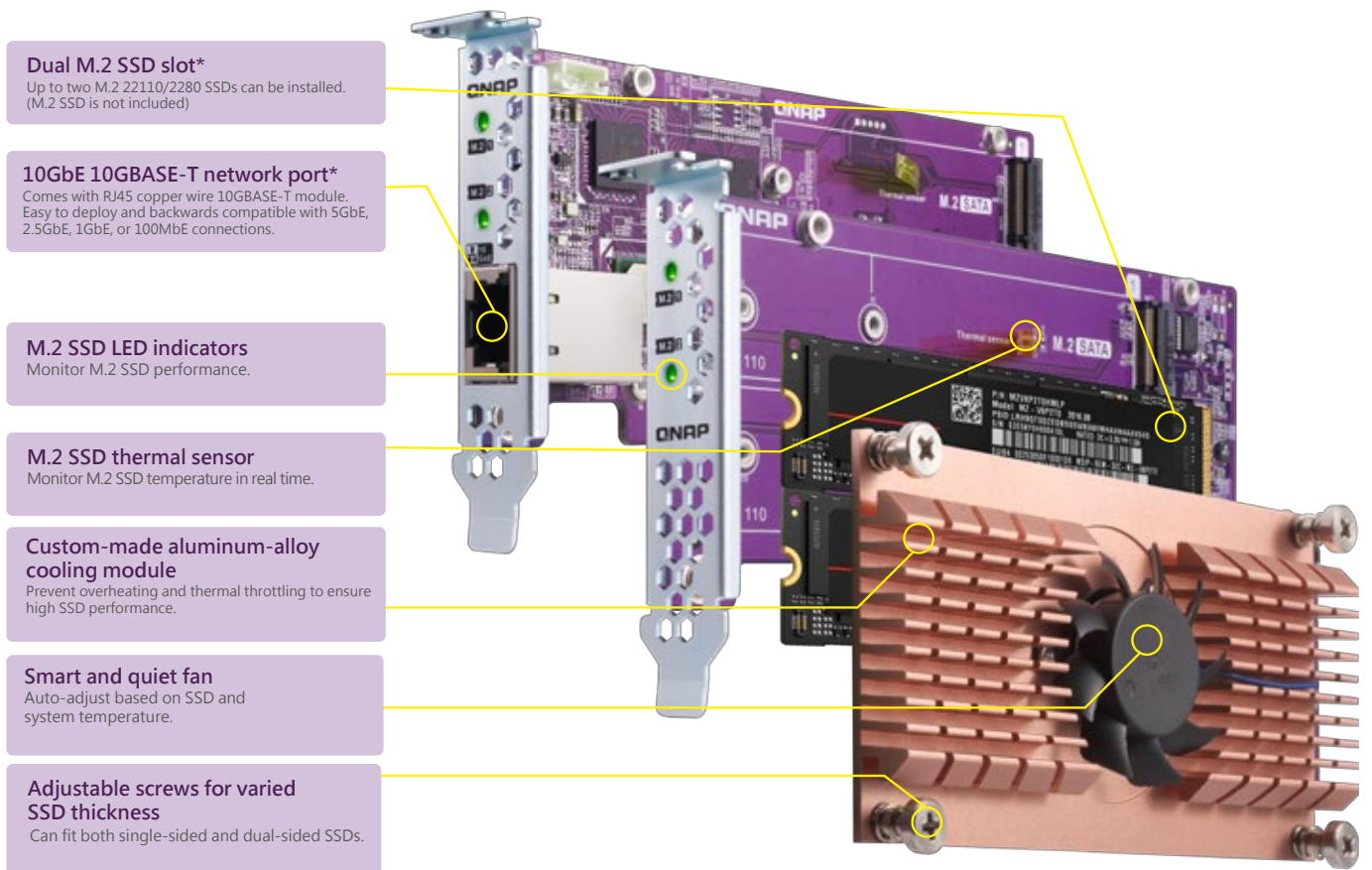

Dual M.2 SSD slot*
Up to two M.2 22110/2280 SSDs can be installed. (M.2 SSD is not included)

10GbE 10GBASE-T network port*
Comes with RJ45 copper wire 10GBASE-T module. Easy to deploy and backwards compatible with 5GbE, 2.5GbE, 1GbE, or 100MbE connections.

M.2 SSD LED indicators
Monitor M.2 SSD performance.

M.2 SSD thermal sensor
Monitor M.2 SSD temperature in real time.

Custom-made aluminum-alloy cooling module
Prevent overheating and thermal throttling to ensure high SSD performance.

Smart and quiet fan
Auto-adjust based on SSD and system temperature.

Adjustable screws for varied SSD thickness
Can fit both single-sided and dual-sided SSDs.

Ordering SKUs	Specifications
QM2-2S	Supports two M.2 2280/22110 SATA SSDs
QM2-2P	Supports two M.2 2280 / 22110 PCIe SSDs

Ordering SKUs	Specifications
QM2-2S10G1T	Supports two M.2 2280 SATA SSDs and provides a single port 10GBASE-T 10 GbE network port
QM2-2P10G1T	Supports two M.2 2280 PCIe SSDs and provides a single port 10GBASE-T 10 GbE network port

About M.2 SSD

M.2 (originally known as the NGFF interface) was designed to allow smaller expansion cards such as Wi-Fi, Bluetooth, and SSD. Compared to the previous mSATA, M.2 SSD allows system manufacturers to standardize common small designs and to select a corresponding length based on capacity or functional requirements. Common M.2 SSD designs are 2242 (22mm x 42mm), 2260 (22mm x 60mm), 2280 (22mm x 80mm) and 22110 (22mm x 110mm), wherein the most commonly used is 2280. M.2 SSD can either be based on PCIe or SATA. Using PCIe Gen 2 x2 as an example, compared to the general maximum speed of 600MB/s of SATA 3.0, its speed is up to 1000MB/s.

M.2 SSDs do not support hot swapping.

USB QuickAccess for Plug-and-Play use

USB QuickAccess allows you to directly connect a Windows PC or Mac to the TS-x53B via the front-panel USB Type-C* Quick Access Port for easy access to files. USB QuickAccess is especially useful for users with limited networking experience or for those just wanting direct access to files. After finding the TS-x53B in Qfinder Pro**, NAS shared folders can be easily accessed without complex network settings. Access permissions can also be set up to ensure data security.

*The USB Type-C cable is not included.

** Qfinder Pro and USB QuickAccess only support Windows 8.0 (or later) and Mac OS X 10.7 (or later). Some operating systems may require additional drivers.



Real-time and offline 4K transcoding

The TS-x53B uses 9th-generation Intel® HD Graphics to support 4K video, and also to allow the TS-x53B to transcode videos (in real-time or offline) to 4K, 1080p and other resolutions for playing on a wide range of devices across different network connections.

Video quality may vary according to system usage and network conditions.

HDMI output and free remote control

Linux Station and HD Station provide users with incredible options for home entertainment including Plex and VLC. The TS-x53B can be connected to an HDTV or A/V receiver for creating a NAS + home-theater combo. The TS-x53B has two HDMI outputs and supports duplicated and extended display modes. The TS-x53B includes a free QNAP remote control, and the Qremote mobile app can also convert your mobile devices into convenient remote controls.

Video quality may vary according to system usage and network conditions.



High-quality OLED screen with touch-sensitive buttons

The TS-x53B has a new slider design with both a smooth appearance and a tool-free 3.5-inch hard disk installation. The OLED screen design shows the TS-x53B's status at a glance, so you easily view system status (including CPU operation, system temperature, fan speed, hard disk capacity and temperature, Volume and LUN capacity and other information). The capacitive touch button design is not only dustproof, but also provides a variety of settings to allow you easily wake up the screen, change network IP settings, password, or to restart/shut down the system.



Low-cost, flexible storage expansion

The TS-x53B can be connected to a QNAP expansion enclosure to scale up storage capacity without downtime. It is well-suited for companies and organizations looking to archive data such as surveillance footage or audiovisual materials. With QJBOD Express, you can transfer the contents of an entire TS-x53B to another QNAP NAS by using a large-capacity expansion enclosure (UX-500P or UX-800P) without needing network connectivity. In addition, you can also use VJBOD (Virtual JBOD) to expand the storage capacity of a QNAP NAS by using the unused storage space of another QNAP NAS.

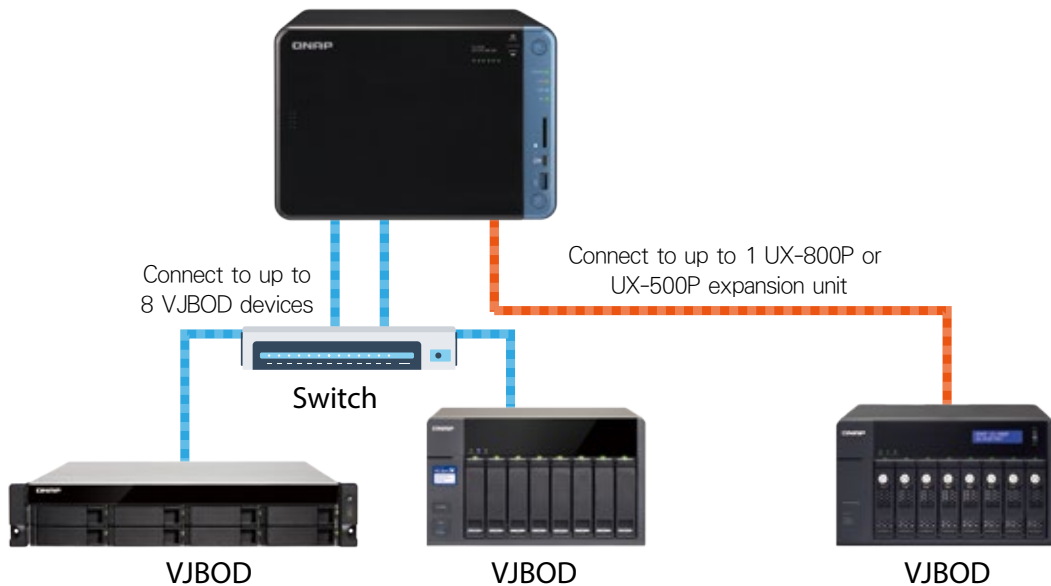

Connect to QNAP storage expansion device to obtain maximum raw capacity

QNAP NAS models	Expansion Enclosure	No. of Expansion Enclosures	Max. Number of Hard Disks (NAS + Expansion Enclosure)
TS-253B	UX-800P or UX-500P	1	10
TS-453B	UX-800P or UX-500P	1	12
TS-653B	UX-800P or UX-500P	1	14

1. A separate static volume or storage pool must be created on the expansion enclosure.
 2. RAID groups for storage pools cannot be spread across multiple expansion units.

Enjoy home entertainment with cloud technology

Multimedia collection center

When a photographer meets TS-x53B

Photographer A: There's never enough storage space! My photos are all stored in RAW file format, so my SD cards quickly reach their capacity. Even when saved to my computer, RAW files take up too much computer storage space...

Photographer B: I want to quickly back up my photos. Photography is for moment catching, and every picture is precious, how can I save my photos in a good manner?

Photographer C: I've accumulated tens of thousands of photos on my computer. Managing photos is really time consuming and cumbersome. I really want a good software to manage my photos more efficiently.

As a photographer, are you often troubled in the same way? QNAP has the solution for you!

Using Photo Station and Qphoto together with TS-x53B series and exFAT credentials, you will be able to solve these problems.



NAS storage space plug & play

The TS-x53B series have USB QuickAccess, allowing you to use a transmission cable to directly connect your NAS to a computer without complex network settings. It is plug and play, same as using USB to transfer photos stored in a camera to the computer. It is just that simple. By connecting a computer to NAS, you can store all the camera RAW files or edited JPG files into NAS and save your computer storage space.

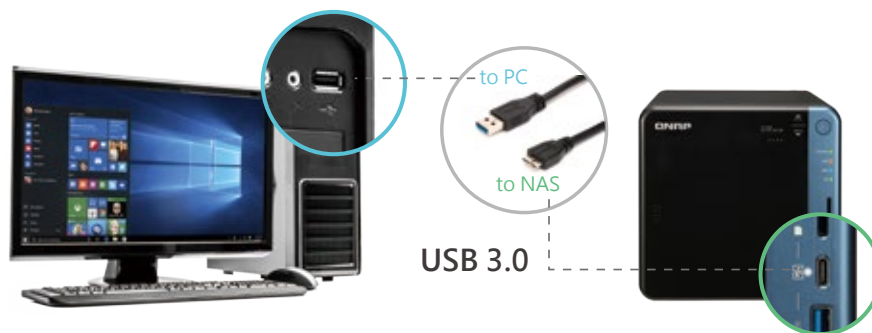

Backup precious photos to keep everlasting memories

By saving photos to NAS, you will not only have more local storage to shoot and preserve more beautiful photos, but also use various QTS data backup solutions to manage your photo backup, restore and synchronization, so precious photos are never lost.



Quickly save high quality RAW files

In addition, you can also purchase exFAT credentials to directly access exFAT-based devices on your NAS. With exFAT support, you can insert an exFAT-based SD card directly into NAS or connect the USB port of NAS to a card reader, and immediately save your photos and videos into NAS without having to transfer files via your computer. It is both fast and convenient.

Safeguard and share your precious moments **Photo Station 5.3**

With more and more high-quality photos and cameras, everyone can become a photographer to record life's precious moments. However, are you still using traditional methods to manage and share photos? Photo Station can manage photos through virtual albums, categorize photos through tagging, quickly search and share your photos and meet your needs for photo management.

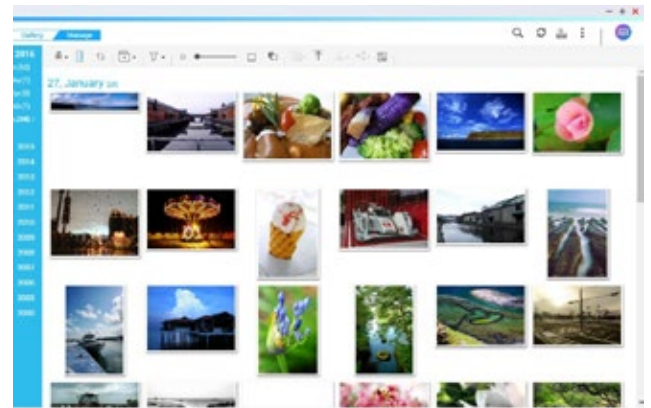

Virtual albums, easy management

Virtual Album frees you from file path restrictions, so that you can easily create albums for all sorts of things in your life, without worrying about saving too many file copies. You can also create smart albums according to set conditions, so photos satisfying a condition will be automatically added to the album. Albums free you from restrictions of complex NAS folder permissions settings. You can simply select the account that you want to share in the album settings, or by sharing the link, then you will be able to share photos to users without an account.

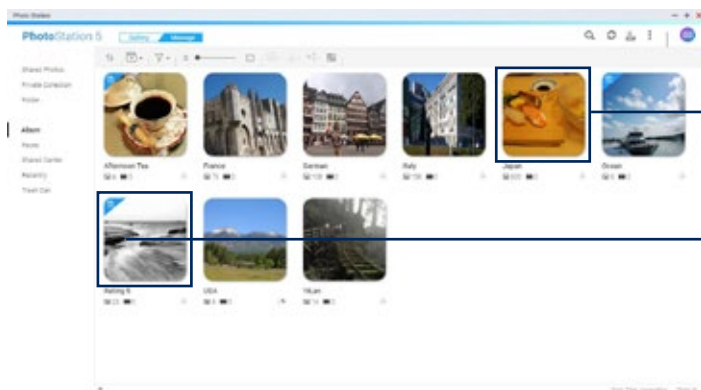

• General Album: manually add photos.

• Smart Album: set time, label and other conditions, automatically add photos satisfying these conditions to the album.

Advanced Search for specific photos

Provide various search conditions, search according to title, tag, date, camera model and other conditions to quickly find a specific photo.

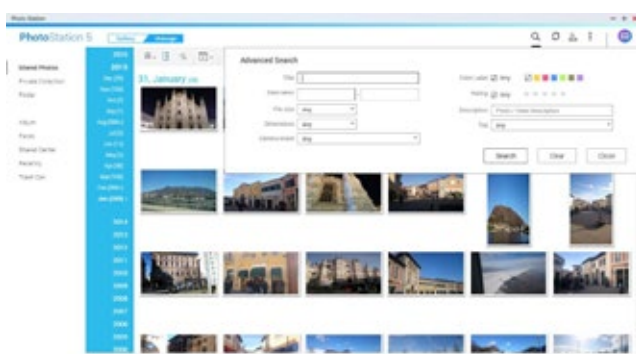

Advanced folder permissions

Photo Station 5.3 supports advanced folder permissions. You can set up permissions for each sub-folder in the Control Panel, then each user can only view photo/video of allowed folders in Photo Station, making permissions management more accurate and simple.

Easily share photos

Photo Station provides the "Share" feature, allowing you to easily choose desired photos and share them with friends and family; while sharing links, you can also set up password and expiry dates to increase security. You can also directly upload photos or videos to Flickr, Picasa, Twitter, YouTube and other online communities.



Enjoy through slides

Whether in Photo Station or with shared links, you can always enjoy the photos through slide shows. You can also choose playlists in Music Station, and play different music for different albums to create perfect moods for your enjoyment!

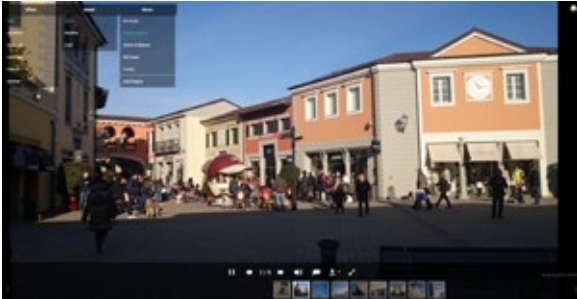

Right-click lock to prevent photo saving

Photo Station disables mouse right-clicking. You can also disable the download function in the settings, so that friends receiving the shared link can view the photo but cannot download it.



High-definition enjoyment

QTS automatically creates thumbnails in three sizes for your photos. It supports multiple photo formats, so you can enjoy the best quality and speed in your phone, tablet or computer, allowing you to browse smoothly even on a mobile network.



Map mode

You can enable map mode in any album, then relive your memories through markers on the map.

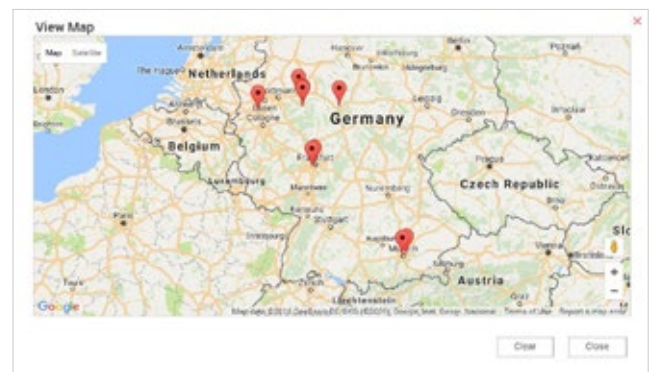

Special column



Photo Station extension kit

Through the Photo Station extension kit, you can tag faces, convert PDF files into albums, and play an album as a series of photos.

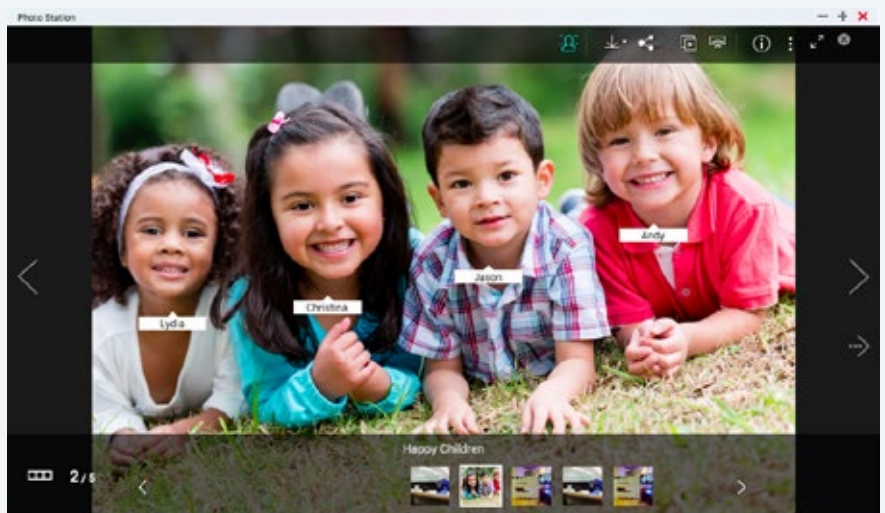



Supports exFAT file system - fast collection of your photographs

QTS 4.3 supports the exFAT file system. Just connect a SD card reader to QNAP NAS USB port, then you can back up your photos and videos directly to the NAS, and view them through Photo Station and other apps. You can also share with other photographers, colleagues, family and friends through network media players or HD Station without using a computer.

✍ To use the exFAT file system, you must first purchase a license. Please contact your local reseller or visit license.qnap.com for more information.



Qphoto - Mobile photo gallery

✍ Supports: iOS®, Android™, and Windows® Phone / Tablet devices

Instant photo and video, instant upload

Often delete photos due to insufficient mobile storage? Take photos and videos directly with Qphoto and automatically upload them to your NAS. Qphoto combines photo taking and uploading so that you can upload as you shoot. You no longer need to worry about insufficient storage, as photos are immediately stored in your NAS. This saves local storage space while ensuring no important photos are ever lost.



Instant photo sharing

Share photos from your QNAP NAS to Facebook, Twitter, Google+, WhatsApp, Line, Instagram, Gmail and other platforms.

Local photos can be viewed as well

Qphoto can browse not only the photos on your NAS, but also the photo library on your mobile device. You don't need to switch apps to see your photos, you can easily browse all your photos, uploading photos and managing them are just as convenient.

Photo browsing

Browse your photo collection using a timeline view, thumbnails, detailed list view, and folders.

Support advanced search

Use keywords or tags to easily find specific photos & videos on your QNAP NAS.

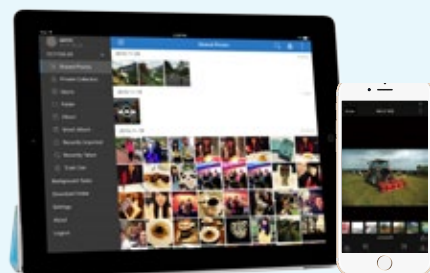



In pursuit of video and audio excellence

Video Station 5.0

Video Station continues the fine tradition of QNAP in thorough consideration of user requirements and constant quality improvement. Video Station provides a new interface to facilitate sharing. It has comprehensive search modes and multilingual support of movie/TV data. During playback, it provides embedded audio/subtitles, and you can add bookmarks to videos to remember your favorite parts. It also comprehensively restructures TV shows to display TV series according to season/series number, and filters for directors, actors and other information. Additionally, it has added a convenient "follow a series with a keystroke" feature. QNAP has put in significant effort to enhance your audio and video experience.

New interface

Video Station has been greatly improved based on user feedback. It allows you to enjoy your videos without distraction, and to show off your cherished collections through the beautiful Video Station interface.



Easy sharing

Video Station provides QNAP's sharing shopping cart design. After selecting videos that you want to share, you can share the video link to friends and family, and upload the videos to YouTube, Youku and other well-known video sites.

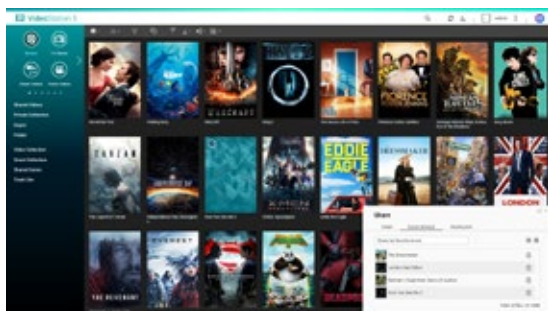

Advanced search

Gone are the days where you could only search based on limited conditions. Now you can set a combination of search criteria, according to title, tag, video length, view progress and more, which allows you quickly find videos.

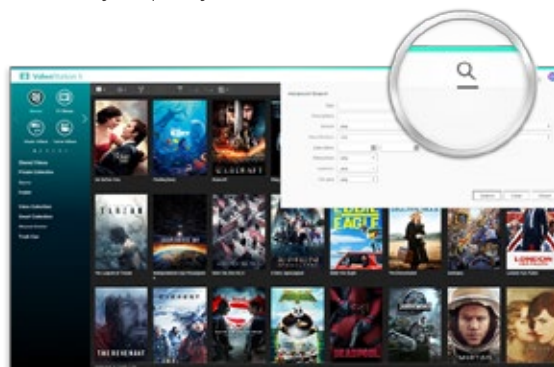

Sharing Center

For all your shared videos, Video Station will arrange them for you in the Sharing Center. You can manage videos based on shared content, for example: delete shared links, share view history and even share again with other users.

Play bookmarks

You can insert bookmarks into videos and remember your favorite clips, so the next time you can quickly jump to the clip to watch. It is also possible to edit the bookmark along with other users, and share favorite clips.

Embedded audio / subtitles

If a video has embedded audio or subtitles (for example: MKV format), then you can select it in the player, and easily switch between different audio and subtitle languages.

✂ Playing embedded audio and subtitles requires transcoding.

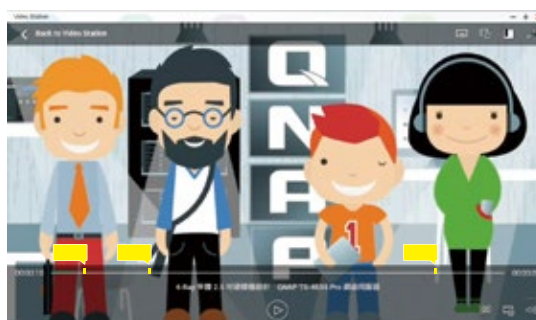

TV program structure

You can organize your TV programs according to season/series, so that you can easily find desired episodes and play a TV series in the same playlist, automatically playing the next episode after finishing previous episodes without any pause.

✍ You must name the videos in a TV program in a specific manner, for example: "Game of Thrones.S06E01.mp4" will be categorized as Game of Thrones, sixth season, episode one.

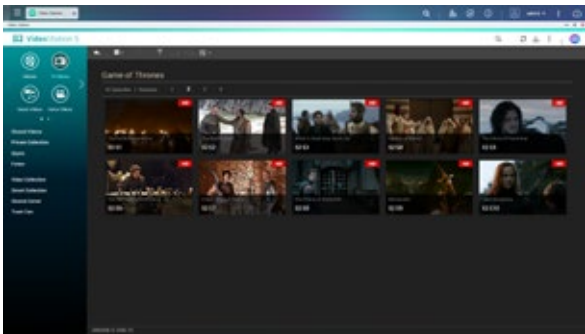

Online database support

Video Station 5.0 coupled with QTS 4.3 supports downloading information from online databases to improve video information.

Follow a series with a keystroke

Automatically remember where you stopped watching last time, so you don't need to remember the season and episode you watched last time. With a simple keystroke, you can continue where you left off.

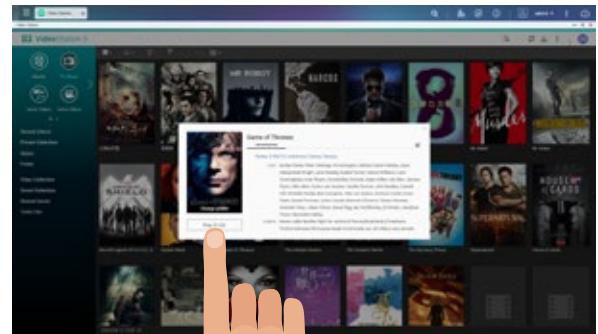

Qvideo - a mobile cinema

Qvideo is a free mobile video management tool designed specifically for Video Station. It allows you to play videos on the QNAP NAS at any time and from anywhere, or share your favorite movies with friends and family.

✍ Supports: iOS®, Android™, and Windows® Phone devices

Download videos to watch at any time

While traveling and sitting on a bus, are you bored by network instability? Just download the videos from the NAS to Qvideo before departure to enjoy a smooth video experience even in a tunnel or on an aircraft.

Rapid share

It's quite easy to share videos through Qvideo; it fully integrates with various communities and communication applications, so you can always share your favorite videos with friends and family!

Supports Airplay®, DLNA® and Chromecast™ streaming devices

Use Qvideo as a remote control to enjoy videos with the ones you love.

Support Mini-player and playlist feature, so you never miss a good film

Qvideo supports Mini-player and playlist, allowing you to continually add videos even at view time, so your enjoyment is never interrupted; just be aware: time flies so quickly, before going to bed it's already dawn!

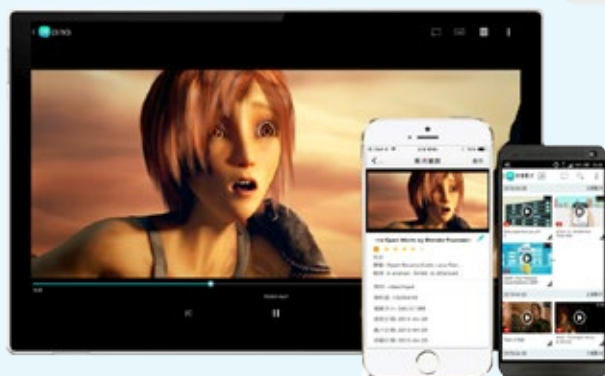



Your personal music cloud **Music Station 5.0**

Music Station not only plays music from PCs and mobile devices through the network, but it is also your personal cloud music center. Simply connect to the Internet, and you will be able to enjoy your music even away from home. Managing a large music collection is often a headache for music lovers; Music Station provides multiple categorization and browsing modes for you to choose from, and you can create up to 200 playlists. You will never be let down simply because desired music cannot be found.

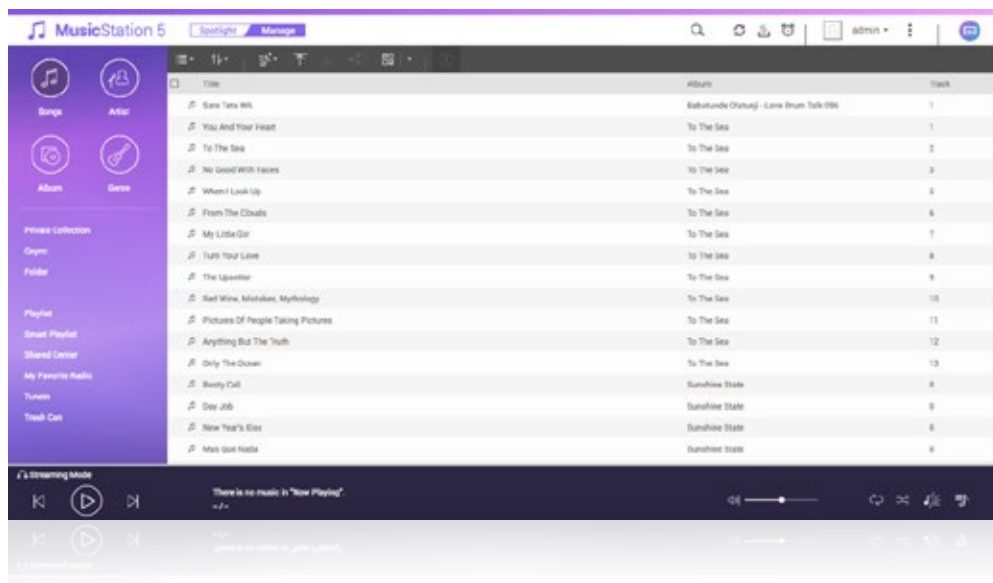

New Spotlight mode

The new Spotlight mode allows you to switch between Spotlight and Manage mode easily to perform different functions. In Spotlight mode, Music Station will automatically recommend different playlists to you, such as: Random [100], [Top Rated], [Recently played], etc. You can also pin customized playlists on the Spotlight page, so that each time you open Music Station, you can quickly find your favorite playlist to directly start playing!

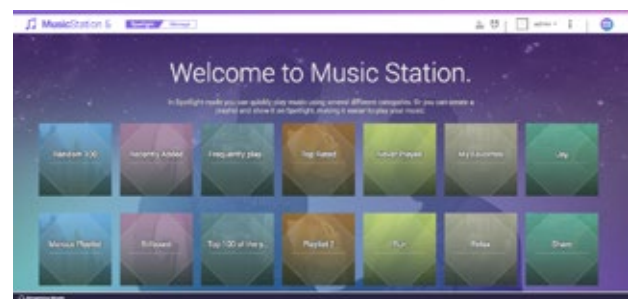

Smart playlist

With the new smart playlist feature, you can set different criteria to quickly create favorite playlists. If you want to listen to pop music of the 80's, just select (smart playlist) when adding a playlist, and add the year condition, Music Station will automatically grab all matching songs, it's this simple and convenient!

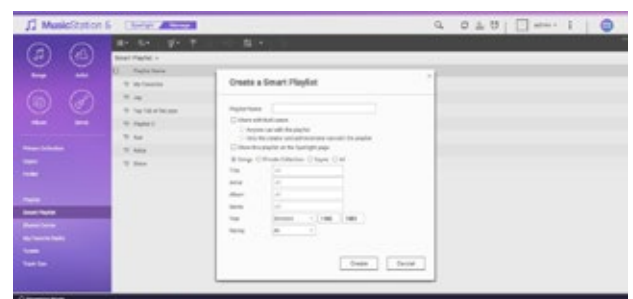

Custom album covers

While listening to music, we also entertain you visually! Music imported into Music Station will have album covers automatically downloaded. If you are not satisfied with the results, you can also upload your own images or find a more-appropriate album cover through the built-in search engine.

Play music on multiple devices all at once, with a simple key stroke in QNAP NAS!

Music Station no longer plays music only through the browser. Now, you can simultaneously stream music to play on different devices. Music Station supports multiple streaming protocols, such as: AirPlay®, Chromecast™, DLNA, Bluetooth, HDMI, USB and more. Just click the earphone icon on the control column to begin streaming music to home amplifiers, Apple TV®, Chromecast™, Internet TV, Bluetooth speakers or even USB speakers (can play on multiple devices all at once). QNAP NAS is the music entertainment center at home!

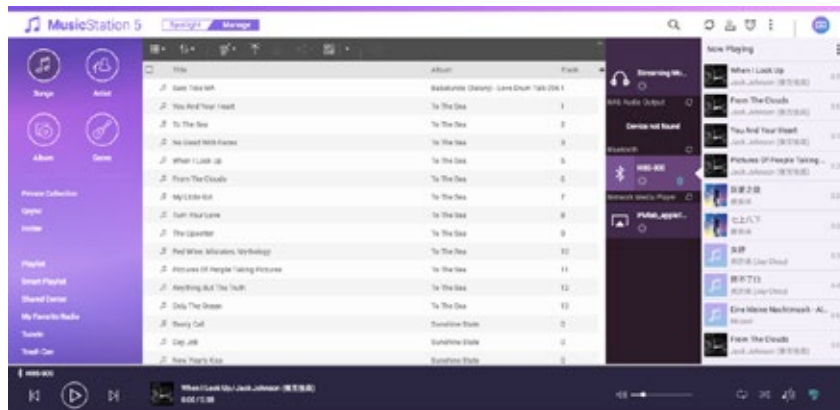

Qmusic - Mobile music library

Through simple connection and selection, you can now stream music stored on QNAP NAS. It's so easy to have a mobile music library, taking your music collection wherever you go.

✂ Supports: iOS®, Android™, and Windows® Phone devices

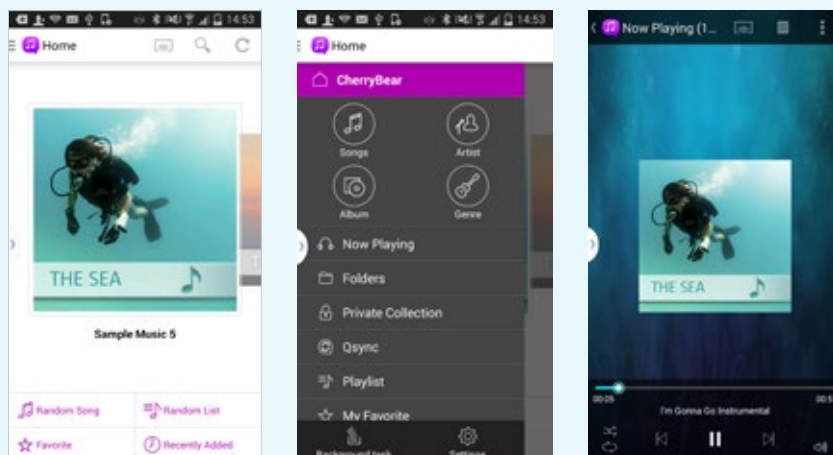

Play any music with a simple key stroke

With so many rapid play features, you can play music based on your mood: play any music, play your favorite music, randomly play any music playlist, or play the latest additions immediately.

Editing playlists online

Easily create playlists, edit list contents, or save the [Now Playing] song list as an individual playlist.

Download music, play offline

Want to listen to music even without a network connection? Just click [Download] to download music from the NAS to your mobile device, so that you can play music without an Internet connection.

Browse music library to your liking

Can you not find the songs you like? Qmusic allows you to browse music on QNAP NAS according to song title, artist name, album, folder and more, so you can easily find the song most suitable for your current mood.

Efficiency boosting techniques are made public

Smart workflow



Workflow automation to improve work efficiency

IFTTT Agent

The Internet has become an indispensable part of our daily life and work, and more and more Internet services, devices and platforms have emerged. In an effort to make routine work more automated, a software called "Workflow Automators" has emerged. Such software allows users to design very subtle application processes with just a few clicks. One application can trigger another application to react to it, thus opening a door for us and bring wonderful productivity gains.



IFTTT Overview

IFTTT ("If This Then That") is a popular web automation service that allows users to link a variety of networking devices / services to create a simple but powerful application-to-application workflow. For example, if Gmail does something, then Facebook will do something else in reaction. IFTTT refers to the workflow as an applet. All registered IFTTT network services have their pre-defined set of trigger conditions and actions. Applets are created by combining the triggers of a service (such as Gmail) with the action of another service (such as Facebook). There are currently more than 300 services registered with IFTTT, and through the vast user base, IFTTT service executes more than a billion applets every month.

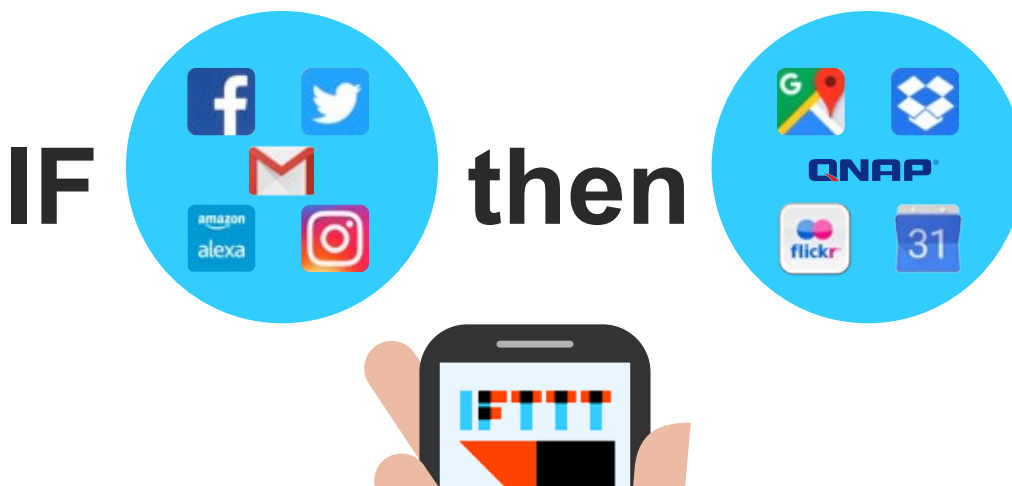

IFTTT Agent makes NAS significantly more efficient

IFTTT Agent can connect your QNAP NAS to IFTTT to enhance productivity. Users can connect their IFTTT accounts to QNAP NAS and then create a limitless number of NAS-associated applets on the IFTTT website. IFTTT Agent is responsible for ensuring that these applets can be smoothly executed on QNAP NAS. Users can freely build their own automation workflow, and enable QNAP NAS to stand out from the competitors. IFTTT Agent aims to change how users perform non-technical work on their NAS, thus improving the quality of life and user experience.

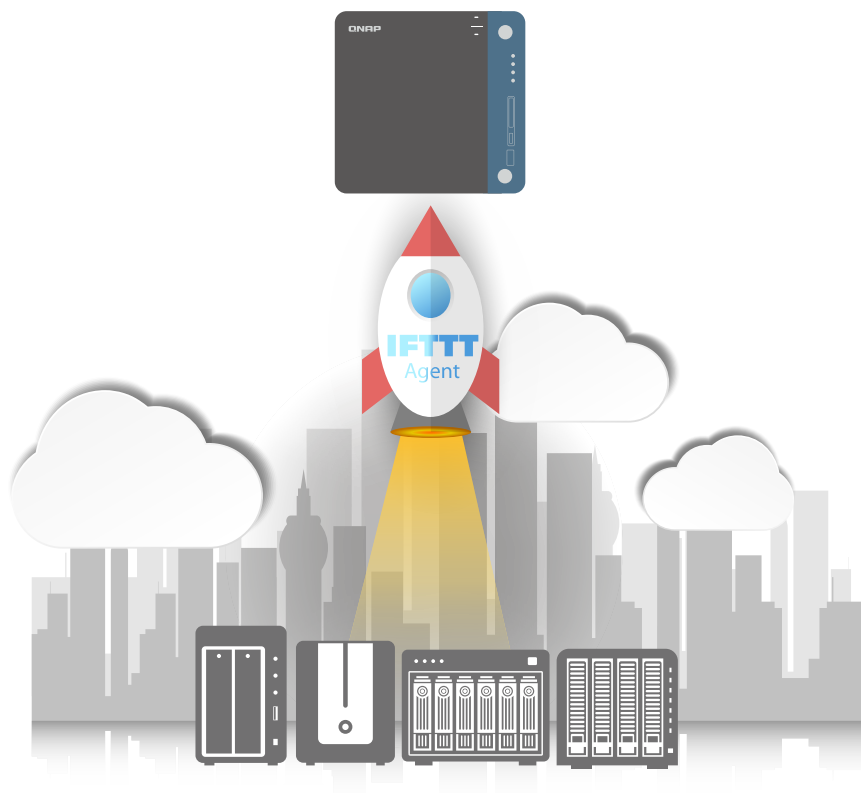

Connect your favorite apps to the NAS

IFTTT Agent takes full advantage of myQNAPcloud to build a secure and robust connection to the IFTTT cloud. With myQNAPcloud's high availability feature, users can simultaneously execute an almost-unlimited number of applets. QNAP provides the perfect architecture to ensure that applets can be successfully executed, in an almost perfect manner.

Real-time Notification

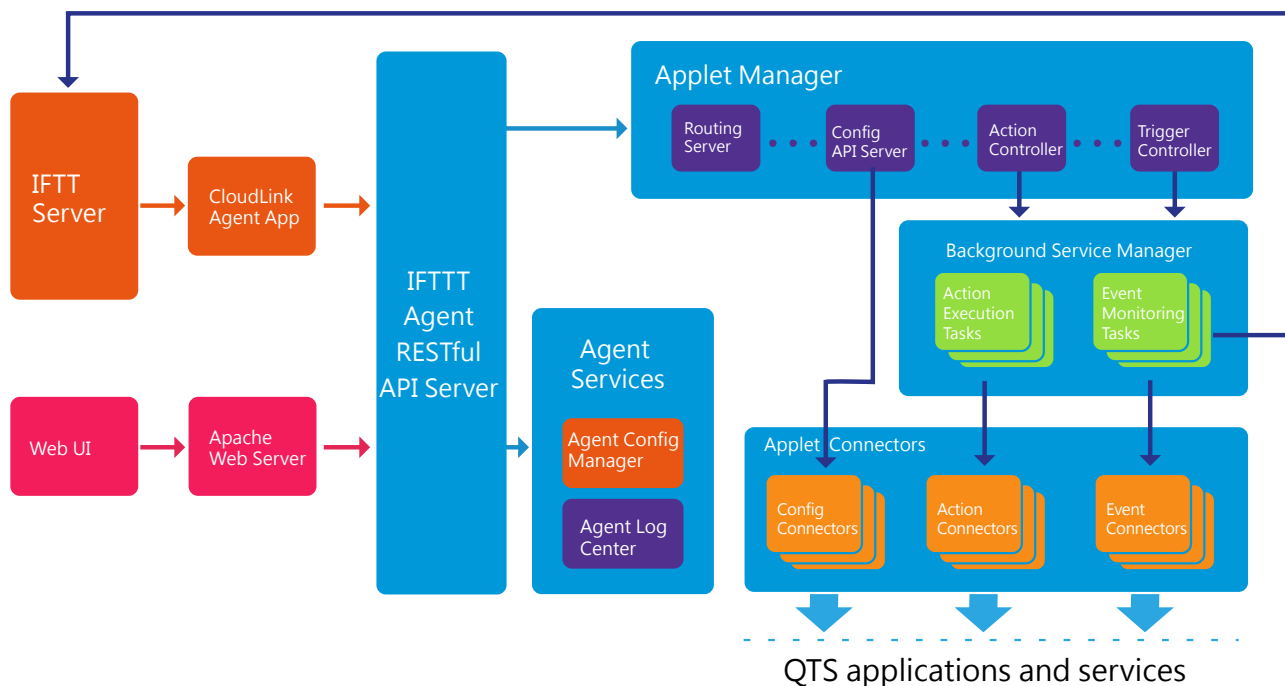

Life-changing applets, significant improvement of user experience

Users can create countless applets in IFTTT to automate day-to-day work. With the latest set of triggers and actions provided by QNAP, users have multiple ways to automate NAS workflows.

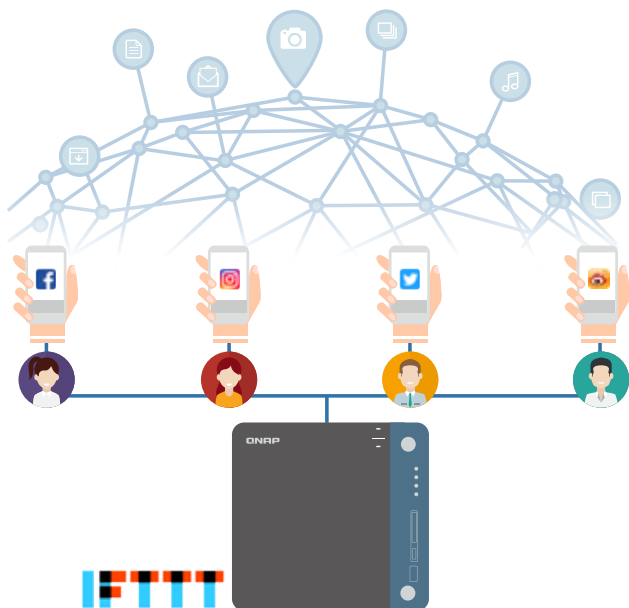

1 Archiving social network data effortlessly

Most Internet users use social networks (such as Facebook, Twitter, Instagram, Flickr, and SinaWeibo) to share photos and videos with friends. For most users, manually backing up such media content to the NAS is very cumbersome. In view of the fact that NAS is mostly used to back up private data, IFTTT Agent provides applets that can automatically archive social networking data.

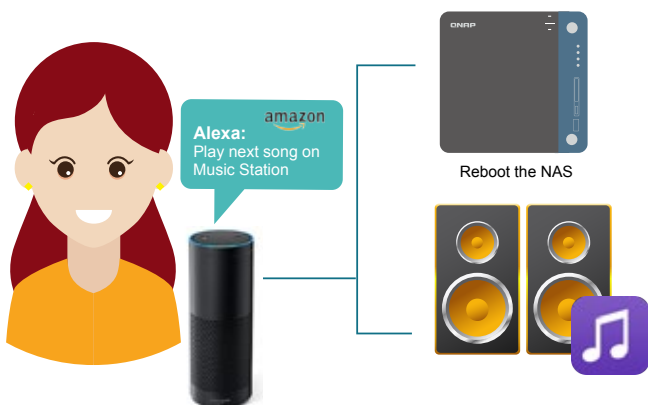

2 Use Amazon Alexa to control QNAP NAS

Amazon Echo and its virtual assistant Alexa is one of the best smart home products on the market today. IFTTT provides Amazon Alexa channel to help QNAP NAS users control the NAS via voice commands. For example, the user may ask Alexa to restart the NAS, shut down the NAS, or make it enter sleep mode.



3 Double the synchronization speed between NAS and other cloud services

NAS is the most commonly used device for storing and backing up data. IFTTT Agent can help NAS users simplify bi-directional file synchronization between NAS and cloud services such as Dropbox, Google Drive, Amazon Cloud Drive, Microsoft One Drive and Box. As the number of cloud services continues to increase, this is the best solution to improve online backup speed and efficiency.

4 Enhance Music Station user experience

The Music Station user experience will be greatly enhanced because IFTTT Agent can be used to provide a user context, so that it automatically plays music when a user arrives at home or stops playing when the user leaves home. The user can stop playing music when the lamp is turned off, or use Amazon Alexa to play music stored on the NAS via voice commands.



5 Forget all the stress and fully enjoy your vacation

QNAP NAS offers the best solution for you to enjoy a carefree holiday. You can create an applet to automatically collect photos taken on your mobile device, then store these photos smartly to a NAS folder. Photos taken with your best companion device can also be saved directly to your NAS. In this way, you will be able to save your device space and more easily share your holiday photos through automatic backup.





Manage all files from a single interface

File Station 4.3

The all-new File Station boasts a more elegant interface. In addition to the remote mounting feature in the previous version that allows you to manage NAS content, external devices, remote NAS, and cloud files, file management operations and various other details are further optimized.

Comprehensive range of basic operations

To upload files using File Station, simply drag and drop files and directories from your computer to the File Station interface to import them to the NAS. File Station also allows all basic file and folder operations, such as: renaming, copying, moving, deleting, and compressing/uncompressing multiple files and folders. To facilitate easy organization, multimedia files of various formats are also displayed as thumbnails.

✍ You can also configure folders as multimedia folders by right-clicking a folder and selecting the required properties in File Station, as well as specify the type of multimedia files to be indexed.

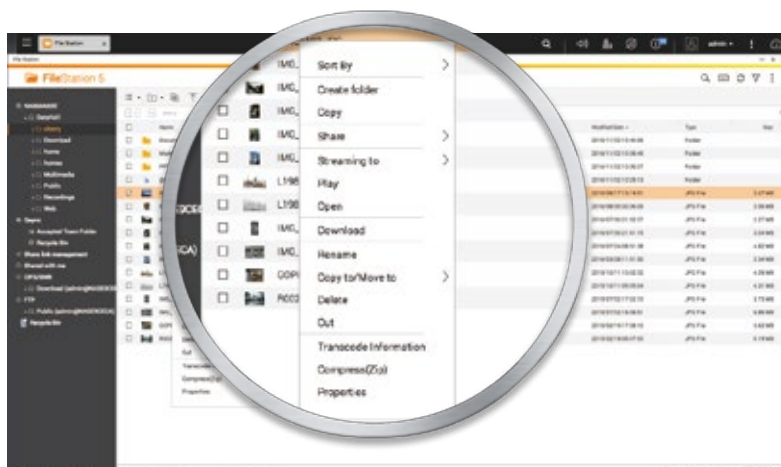

All files at a glance

In addition to viewing files on the local NAS and USB devices, File Station supports accessing files from external devices such as Blu-ray and DVD drives. This provides a total file management solution from within a single window, and allows the easy centralization of all your files. With remote mounting, it can also read remote NAS or files hosted on cloud storage.

Now supports: Blu-ray / DVD / SD Card



✍ Refer to exFAT file system section for more information.

Remote mounting at your fingertips

The remote mounting function provided by File Station allows you to mount files from a remote NAS to your local NAS via CIFS/SMB or FTP without logging in to a different device. Using the Connect to Cloud Drive app, you can also mount cloud storage spaces. Eight cloud services are currently supported: Dropbox, OneDrive, OneDrive for Business, Google Drive, Yandex, Amazon Drive, Box and HiDrive, allowing you to easily browse all the files through a single window.



In the past,
you needed to log in to different devices to
copy and transfer files.





Now,
you can connect to remote devices/cloud
spaces through File Station.



Mounting offers a new range of applications

With remote mounting, you can quickly access files on other servers for data migration. If your needs are not just remote file access but local storage expansion, you can use Virtual JBOD (VJBOD). After mounting, the local computing resources can be used to perform snapshots, transfer and more, it is as flexible as using local space.

	Remote mounting	Virtual JBOD
User Interface	 File Station	 Storage Manager
Connection Method	CIFS/SMB, FTP	iSCSI
Supported operation level	File-level operation	File and block level operation
Auto recovery after disconnection	Not Supported	Supported
Supports remote devices	Supports all CIFS/SMB or FTP servers	Supports QNAP NAS with block-level iSCSI LUN services
Usage Scenario	Quickly connect to other NAS or servers for file backup	Use the free space of a QNAP NAS to expand the capacity of other QNAP NAS

 For more information, see the VJBOD section

File preview at a glance

File Station brings together various document, file and email preview tools, and is integrated with a multimedia browser - Media Viewer. This allows you to play media contents without having to download them or to use plug-ins such as VLC.

Documents

Through the Google office extension*, you can open Office files (.doc .docx .xls .xlsx .ppt .pptx) and browse their contents directly in File Station. Alternatively, you can also view an Office file by right-clicking on the file and selecting Office Online or Google Docs.

 Only for Google Chrome. You will need to visit the Chrome App Store to download the required [Office editing extension for documents, spreadsheets and slide shows]

Emails

Manage emails backed up through QNAP's QmailAgent with File Station. You can also open your emails (.eml), and reply, forward, or compose a new message directly in File Station.

Music

Play music from a wide range of formats.

Videos

On-the-fly transcoding allows you to watch a video while it is being converted in real time. You can also right-click folders in File Station and set them to automatic transcode video content. Thereafter, any video added to these folders will be automatically converted to the specified video format.

 Only for models that support real-time online file transcoding.

Photos

View a wide range of picture formats and play back photos as a slide show. Additionally, set a photo as the QTS wallpaper directly from the Media Viewer.



Easy sharing of files and folders

Internal file sharing

You can share files with your friends on the NAS easily and quickly through the following methods:

- » Share space with a user: System administrators can allocate space to NAS users, and specify a storage quota in File Station.
- » Directly share with other NAS users: Share files directly with selected NAS users without setting shared folder permissions.

Links for External Sharing

Create Share Links to share files with friends who do not have an NAS account. With File Station SmartShare, you will get directed to the desired site smoothly regardless of the network environment. Register for myQNAPcloud to quickly share files with other users. The new version of Share Links further optimizes your browsing experience through mobile devices.

- » Share download links via email: Users can share links from their own email address.
- » Share with social networks: You can copy and paste Share Links to social networks.
- » Create share links only: Create a share link for files or folders and copy & paste it where you need it.

 Mutual file sharing: You can easily share several files in a shared folder with friends via a Share Link. By enabling the "Allow file upload to this folder" option, your friends can use the Share Link to upload files to your File Station without needing a user account.





Qfile - Access files stored on your NAS remotely

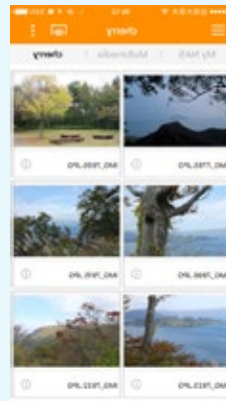
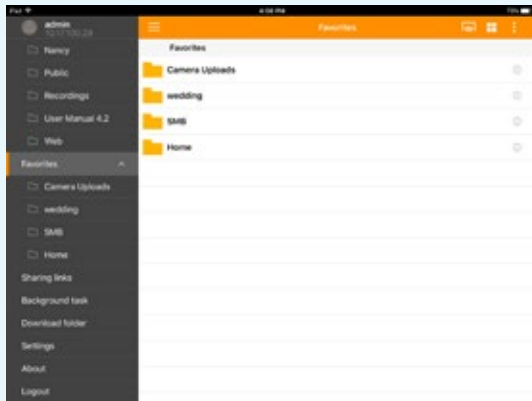

✍ Supports: iOS®, Android™ and Windows® mobile devices.

Versatile and real-time file management

Remotely upload/download, share, manage, and stream files from your QNAP NAS and synchronize files between the NAS and your mobile devices.

Fast search for files

Are you unable to find files amongst the complex and massive amount of data on your NAS?

Advanced Search

You can now find the file you need instantly based on its path, size, type, date, or date modified.

My Favorites

My Favorites lets you pin frequently-accessed folders on the left column to help you browse your files quickly.

Folder and file sharing

Create download links for shared folders or files to share via email, SMS or mobile apps, or email the files as attachments. There is no need to download the files or folders before attaching them and there are no size and type limitations.

Automatic upload of photos and files

When you enable automatic upload, Qfile will automatically backup your photos or the files in your designated folder to the NAS.

✍ Folder synchronization/upload is only supported by Qfile for Android 2.5.2 (and later).





Private cloud notes collaboration platform

Notes Station 3.0

QNAP has launched the new Notes Station 3.0, which adds new collaboration features while retaining the security and convenience of a Cloud environment. With Notes Station, NAS users can edit notes together, and collaborate to create a co-authoring environment.

Optimized user interface

The new interface shows respectively the primary function area, the notes management area and the notes editing area. The newly-optimized UI allows you to effortlessly create, organize and share your notes.

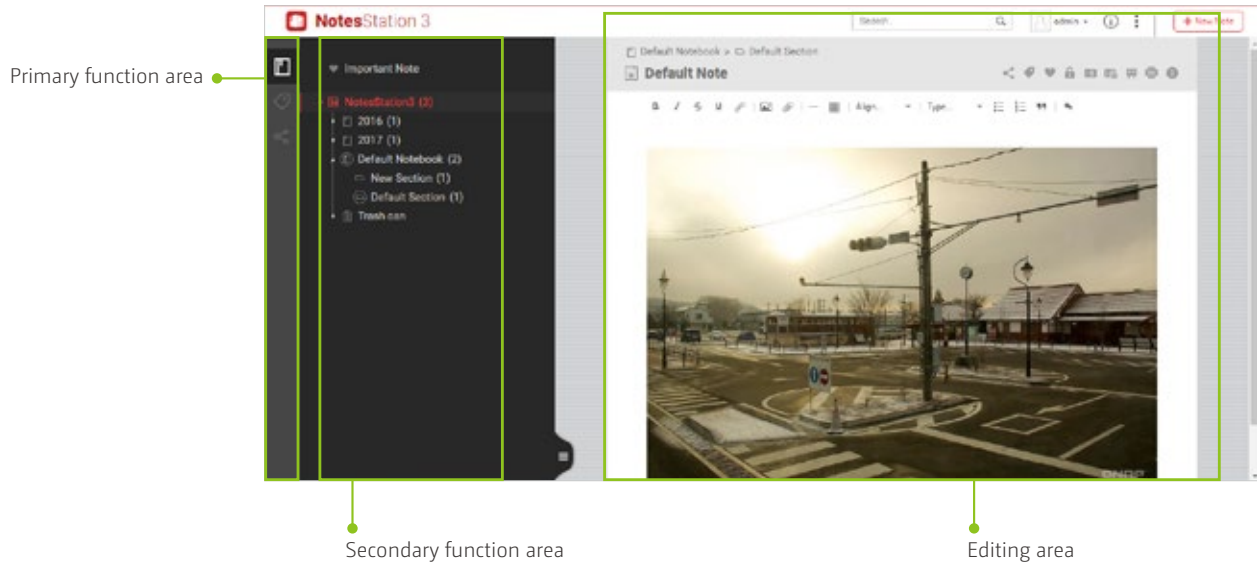

Cross-platform content integration, easy and fast notes management

As long as it's "mounted" and connected to other NAS, you can browse the contents of Notes Station 3 on multiple NAS via the same interface, and easily manage notes on different NAS. In addition, after being connected, you can directly insert and attach photos or archives from other NAS into your notes, so that you can use your resources more flexibly and conveniently.

Newly-launched private cloud notes collaboration platform

Notes Station has complete collaboration features. You not only can co-author a note with other NAS users, but also clearly see the other user's edit records. Notes Station has significantly raised the bar as to how private cloud notes software is used.

The new image editor - your handy tool for creating beautifully illustrated notes

Making appealing documents is no longer an issue, Notes Station has a built-in highly-automated layout editor, so you can easily transform text content into beautiful notes. In addition, you can also quickly place highlights on a picture and do simple image editing.

Tagging and My Favorites - organizing your important notes

In addition to elegant notes management and powerful search capabilities, Notes Station also provides a tagging feature. You can add tags to notes and search for the tags for quicker access. Additionally, you can also favorite often-used notes for easy access.

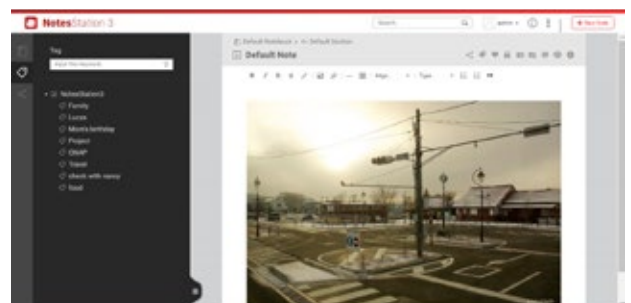
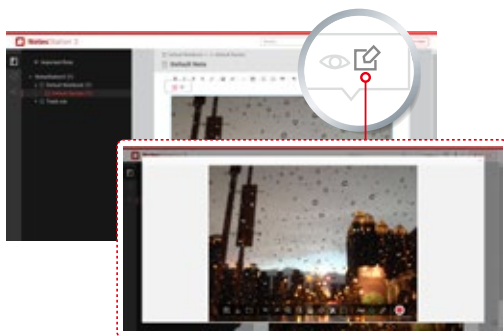

Make life more beautiful by sharing

Sharing has become an essential feature in life. Notes Station has a built-in sharing feature, which requires just two steps. After a successful share, other users can view or edit shared notes.



Public links

If you need to share with non-NAS users, Notes Station also has a public link feature. With a few steps, users can make Notes Station a message publishing platform. Users can also enable password protection while transmitting private messages, in order to avoid information leaking.

Sharing list

While it is very easy to share information, sharing management is not. QNAP provides a new sharing management interface. Whether it is a document shared by others, a document shared to others or public link, you can centrally manage them in the sharing management interface.

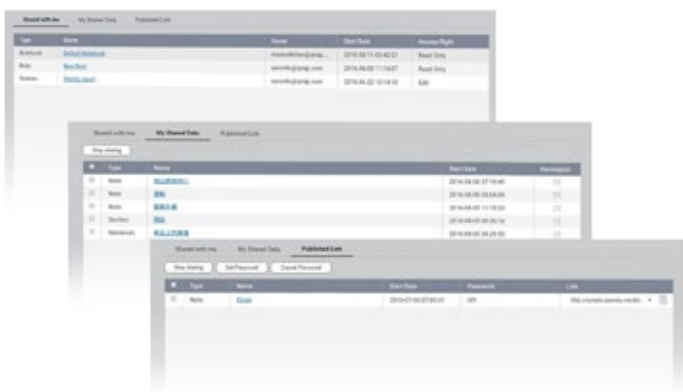

Add NAS files as attachments - all your NAS data at your fingertips

Each user may have lots of data and creative writing stored on the NAS. Notes Station allows you to access data within NAS at any time and turn it into an attachment. You can also directly copy and paste to quickly complete a note.



Data security is the utmost priority of Notes Station

Notes Station also provides four features: encryption, version snapshot, notes export and import as well as full backup to help you properly protect data.

Password Protection - prevents unauthorized access to your notes

Because Notes Station places emphasis on sharing and collaboration, password protection is an essential feature. You can password protect notes to avoid unauthorized access.



Version snapshot

When you are editing content, Notes Station will constantly save a copy for you. However, it's not easy to recall previously-edited content. The best approach is to enable snapshots to save a number of edited versions at different times, for use as needed in the future.

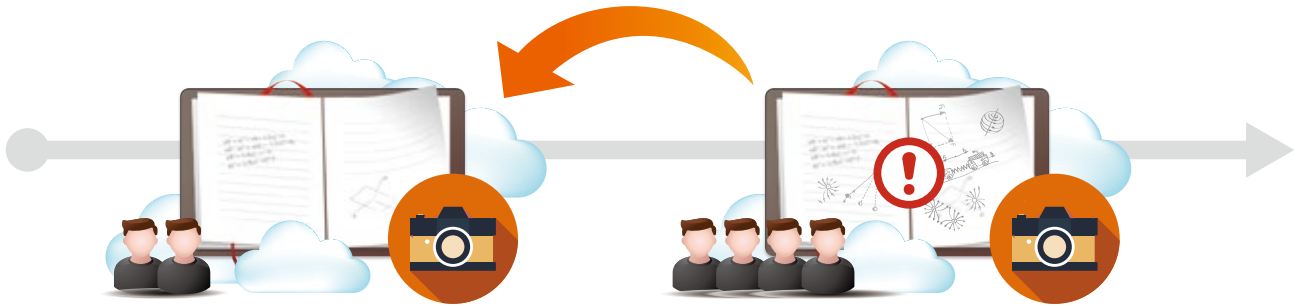

Note export and full backup

Notes Station has a built-in note exporting, allowing you to export your notes to a remote NAS or your own computer. Additionally, NAS administrators can set scheduled backups to prevent data loss due to hardware damage or system failure.



Qnotes 3.0 - Portable notes further evolved

Qnotes has further evolved with the newly-developed private cloud notes collaboration platform Notes Station 3.0. You can invite work partners to edit notes with you, and see your changes to the notes on the device.

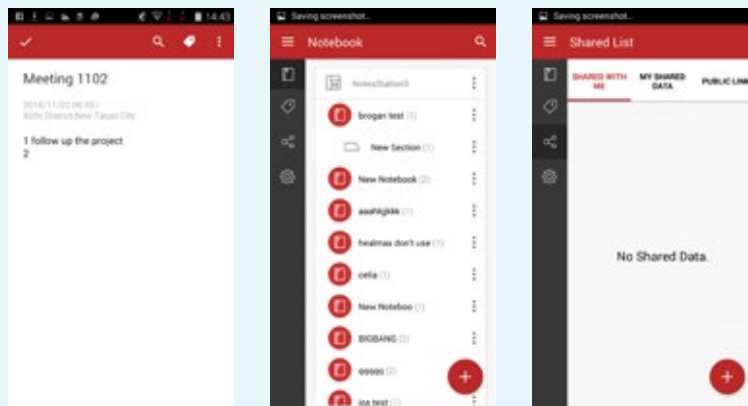

✍ Supports iOS®, Android™, Windows® devices.

Easy-to-use notebook design

With a three-level structure, you can quickly organize and categorize notes. In addition, it also provides a quick note feature, allowing you to record audio, take pictures and write text. You can also open attachments using your phone's built-in media player.

Custom label

Using custom labels in combination with the search function, you can quickly categorize and find notes, even if there are tons of notes.

Sharing list

Qnotes encourages you to share your creation, or invite others to complete the notes. At the same time, the sharing list feature will allow you to clearly see the notes sharing status (shared from others, shared with others, shared through a public link).

Community share

After editing notes, you can always share them with mainstream communities, and share your ideas and thoughts with the whole world.

NAS email agent QmailAgent 1.0.4

QmailAgent is an online email client program that helps you centrally manage multiple email accounts. You can login and access email accounts using a single platform, synchronize and backup emails to the NAS, providing a centralized email platform for greater convenience.

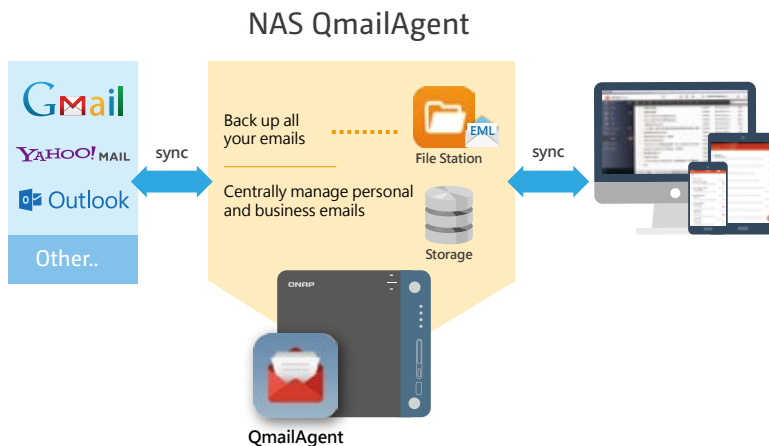

Protecting personal privacy, sending and receiving messages without being hindered by firewall

Email is all around us. No matter where you are, at work, at home, or around the world, you frequently need to send and receive emails through different IP addresses. But logging in with different IP addresses exposes you to potential privacy risks. To boost email privacy, QNAP created QmailAgent - a centralized email platform hosted by QNAP NAS. Once you're logged into QmailAgent, only one IP address is used no matter where you access or send emails. And when traveling in China, you can use Gmail without being hindered by the firewall.



Overcome attachment size limit, securely share any link

QmailAgent's large attachment sharing feature removes size limits and allows you to easily select large files or folders, such as videos, presentations and videos, and automatically creates links with file-sharing methods on the NAS and attaches them to emails. You can also set access restrictions for your files for security and privacy. In addition, to allow recipients to receive attachments of any size when their email service only allows 10MB of attachments, you can use QmailAgent's attachment sharing feature along with CloudLink to ensure that they only need to click on a share link to access the attachments.

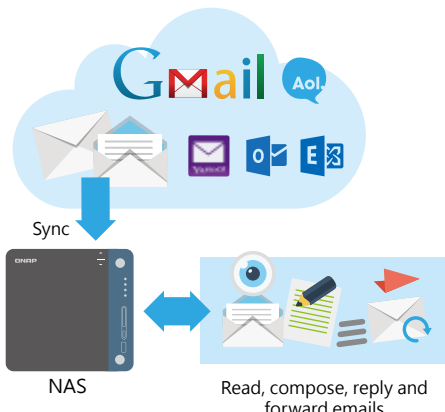
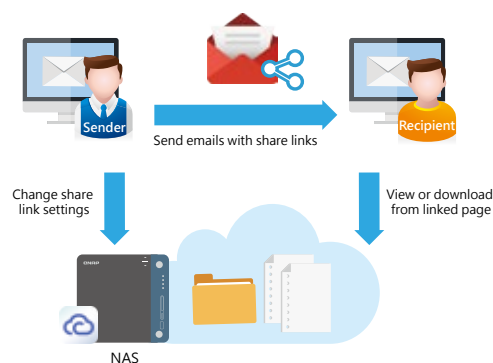

Backup your emails to your NAS

QmailAgent supports unlimited backup of emails to your NAS. Once the email account is set up, it will save all of the emails to the NAS - providing protection against accidental deletion. Attachments can also be saved, making it easier to archive complete emails and convenient for finding required files.

Easy and convenient access to attachments

Sometimes you need to email files without them being close to hand. But if you didn't save it to a mobile device, then you may have to redownload it before sending it again. This is rather cumbersome. QmailAgent combines NAS and the local device, allows you to directly access files, documents and photos on the NAS, and send them as email attachments. Likewise, you can also save incoming email attachments to the NAS.



Viewing and opening, no need to download

With traditional NAS applications in the past, you must download files from the NAS to the local device in order to read or send emails. Now you can read emails using QmailAgent and also open email backups directly in File Station.

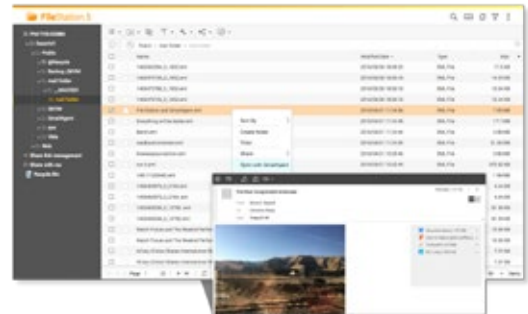

Switch viewing modes with a keystroke

The new version provides instant check of email status on the server, so that you can synchronize all emails to the server via the interface. It also has a backup email view mode. Even if you delete the message on the server after the message is downloaded, you can still find deleted messages in this mode and view and manage the backup messages.

Keyword search, best results

It is not an easy task to find emails amongst a potential mountain of archived and inbox emails. QmailAgent provides an instant search function, allowing you to define the search range (messages inside a sub-folders, or change the search options, such as: sender, recipient, subject, etc) to help you quickly locate your desired emails.

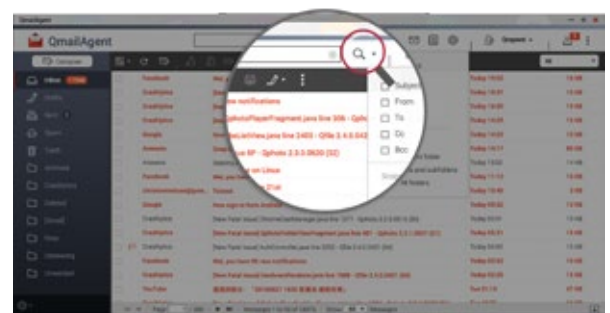
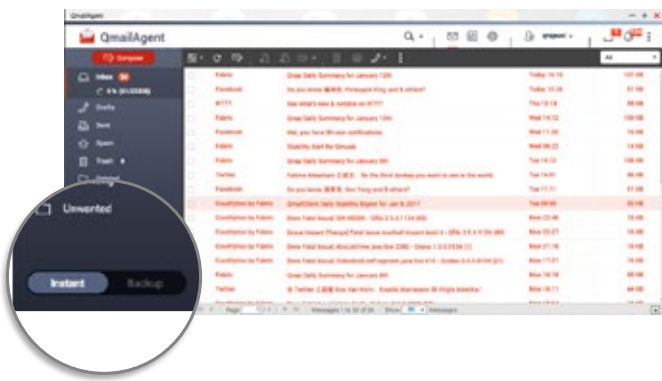

QmailClient-send or receive email at any time via NAS

The benefits of QmailAgent are also directly available on mobile apps with the QmailClient companion app. The system will automatically push new messages to your mobile device. Using QmailClient, you can also save the latest incoming email onto your mobile device, and read them offline at any time.

✍ Supports iOS® and Android™ devices

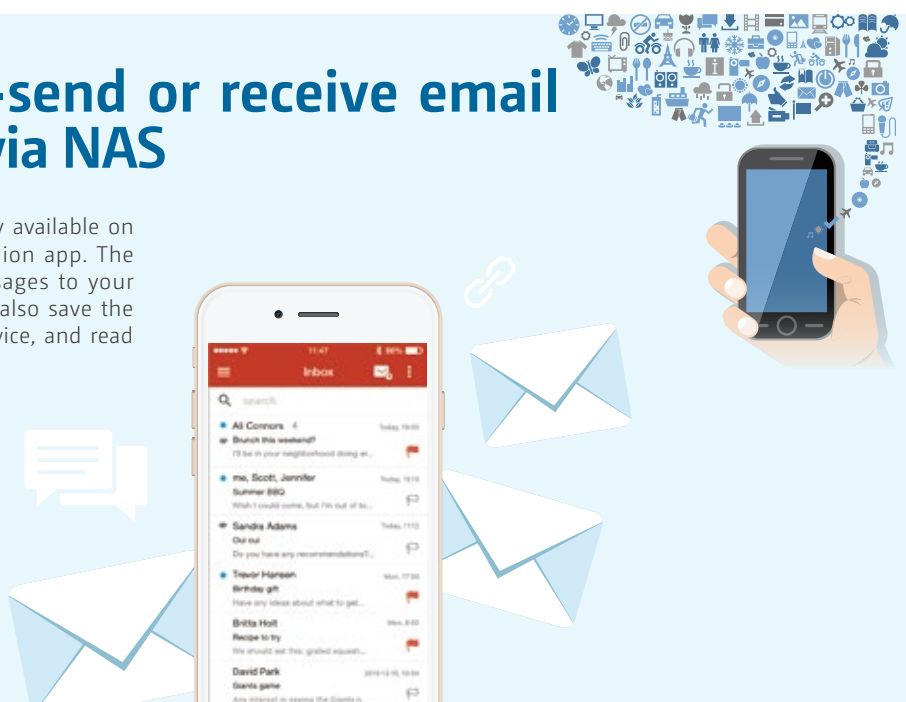



Browse NAS without restriction, and easily connect with any NAS

Browser Station

QNAP Browser Station uses virtualization technology to allow users to easily open a virtual browser on their NAS. When you connect from a remote device to a NAS from any location, you can easily access the web site resources on the LAN through the NAS browser, or you can download files directly from the browser to the NAS.

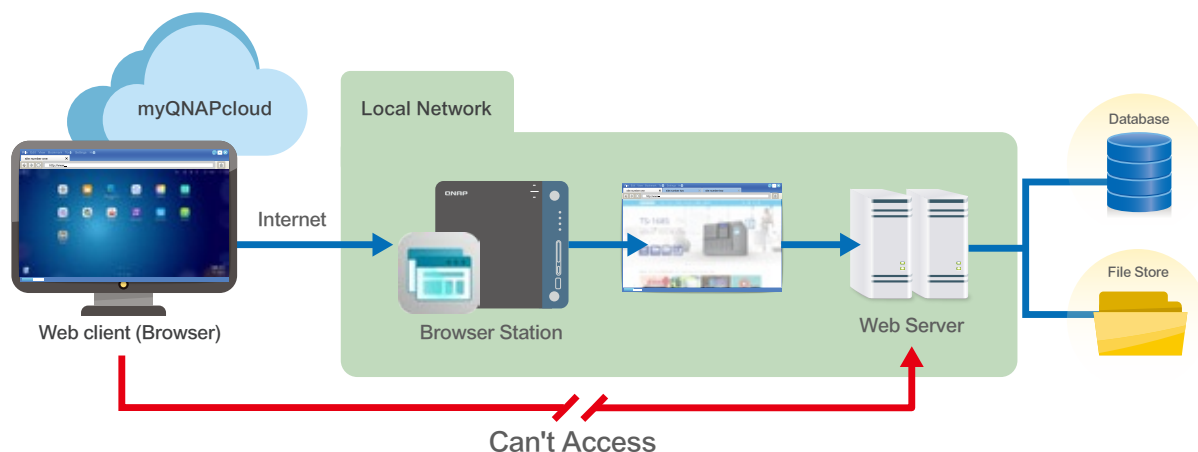

✎ Browser Station currently supports both Firefox and Chrome browsers.

Protect your browsing privacy and security

In the past, if a business traveler wants to connect to the company's internal network or use services restricted through the company's IP address, it is usually done through VPN. Now with the virtual browser service provided by NAS, you can easily access data on the same network, and even use Google and Facebook services if you are geoblocked. You can also use the remote NAS browser as a login entry point to avoid being monitored or logged while browsing the site.

Exclusive management interface

The overview page uses an intuitive graphical interface to make it easier for administrators to use and manage, either through other apps or browsers that are available to users. Through the management interface, you can view the system's real-time monitoring information and system resource status. In case the browser is taking up too much resources and hinders performance, you can adjust your browser's usage at any time.

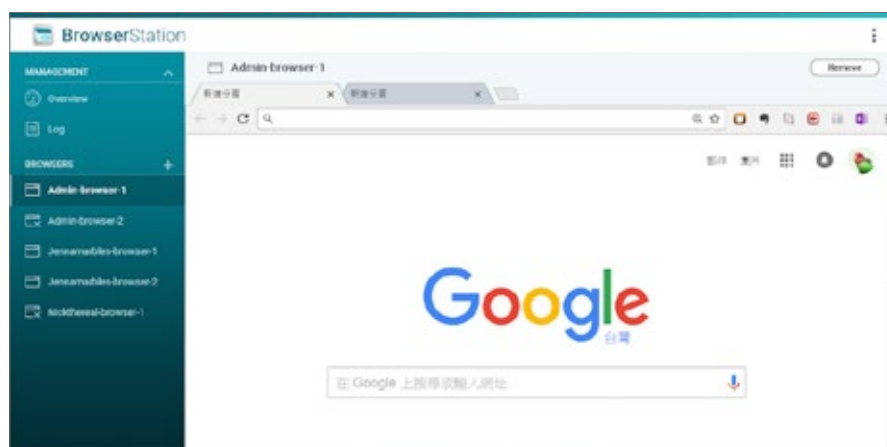

Retain your browser status when changing devices

No matter how many devices you use, Browser Station will always keep the user's usage history, open tabs, bookmarks, recent browsing history, the tab and the "reading list" up-to-date.



Securely store your valuable networking resources

Qcontactz Quantum Contacts Manager 1.0

Each day, we are connected with more people in our community either virtually or in real life. As the number of contacts increase exponentially, management of contact information becomes increasingly difficult. Qcontactz is your own private cloud contact helper, with safety and high-capacity features. Through a highly-secure private cloud, you will be able to store millions of valuable networking resources to ensure no opportunity is lost.

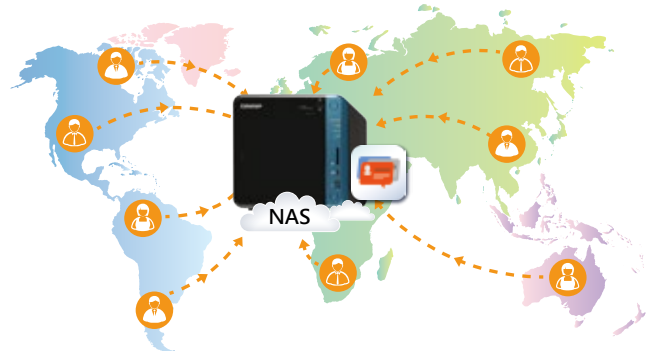

The perfect architecture for the safest private cloud

Backed by the support of a private cloud and with software redefinition, Qcontactz is able to provide a complete database architecture for optimal contacts storage and search. It overcomes the storage limits of computers and mobile phones to let you manage millions of contacts with high efficiency. With password encryption, your contact list is well protected and no confidential information will ever be leaked out.

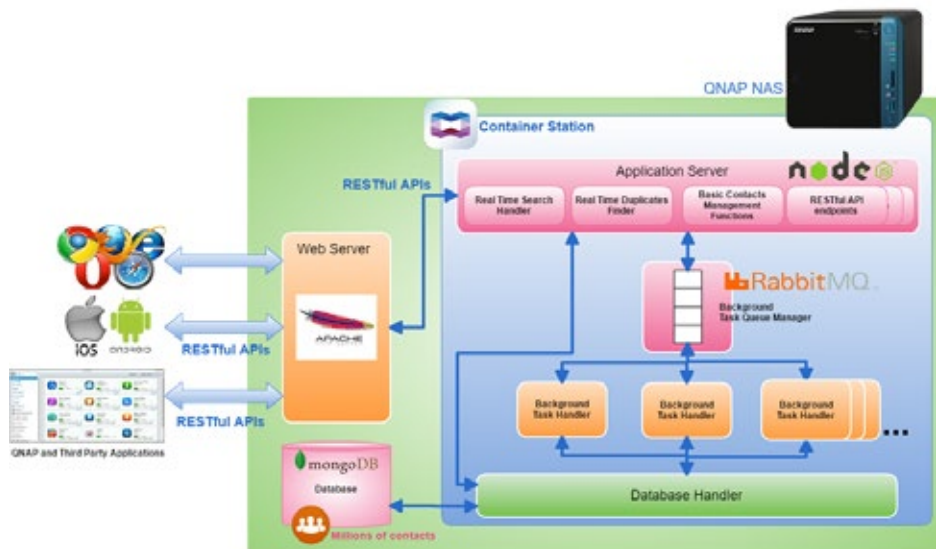

It is the best contacts manager for importing and managing contacts and API applications

Qcontactz supports multiple ways of importing contacts, and can be operated via web browsers using an easy-to-use web interface. It also has the perfect API interface that allows quick integration of Salesforce and other ERP/CRM systems. Qcontactz is the best business and personal contacts management tool.



Download and install Container Station from the App Center before using Qcontactz.

Cross-platform import, integration and management of contact information

Qcontactz supports synchronizing with Google contacts, importing contacts in CSV, vCard, and other file formats, and manual addition of new contacts. When using Qcontactz for the first time, the Quick Tour will introduce you to the following 3 ways of importing your contacts list:

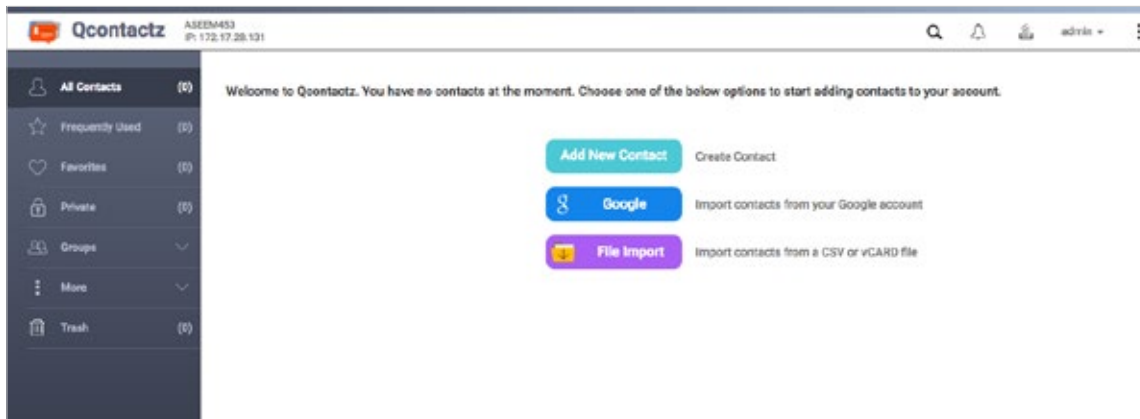

1 Synchronize contacts with your Google account

If you choose to synchronize with your Google account, you'll be able to link up your account and import your Google contacts upon successful authentication. Qcontactz supports import of contacts information from multiple Google accounts and synchronizing updates to these contacts.



2 Import CSV and vCard files exported from various applications

Commonly-used communication apps (such as Skype, Outlook, Yahoo, IBM Notes) all support exporting CSV, vCard and other standard formats, so you can import these files into Qcontactz. When importing csv files, you can flexibly select the contacts and fields you want to import in the Qcontactz interface.

✍ Qcontactz supports vCard version 3.0 (and later). In addition to importing contacts, Qcontactz also supports exporting contacts to CSV and vCard files.



3 Manually create new contacts

You can also create new contacts by entering the relevant information.

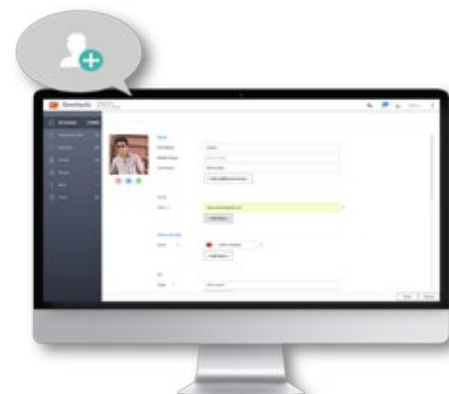

Various smart features to increase social network management efficiency

Merge and combine duplicate contacts with a single key

Qcontactz identifies duplicate contacts. After importing your contacts, duplicate entries can be easily found using this feature. Simply click "merge" to combine duplicate contacts. You can also view your contacts merging history, and restore contacts where necessary.



Social network management is a breeze with Quick Search

Despite having a massive number of contacts, you can easily find specific contacts by searching for their names, email addresses, phone numbers, or other information.

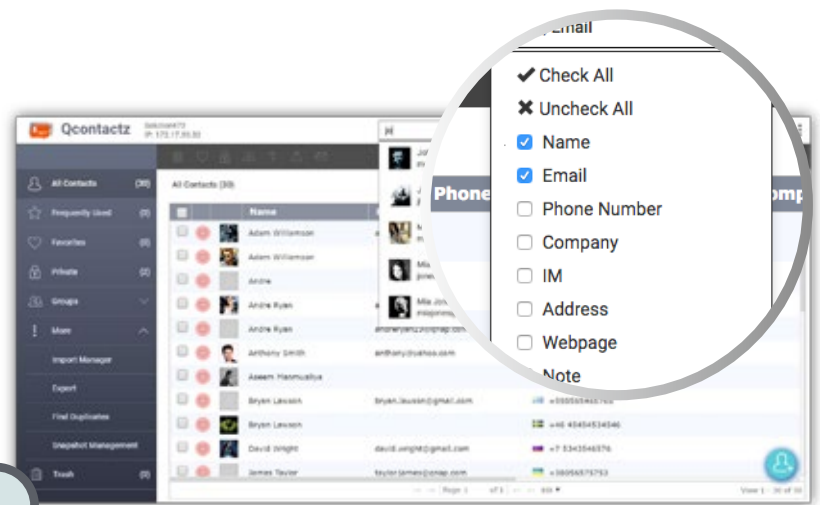

Group management and management of highly confidential contacts

Many people have over a hundred contacts. If these are not categorized, finding a specific contact can be tedious and time consuming. You can organize your Qcontactz contacts using pre-defined groups (such as Clients, Family and Classmates), or add in other groups where required. Confidential contacts can be added to highly-confidential groups, which can be password protected to ensure privacy and security.

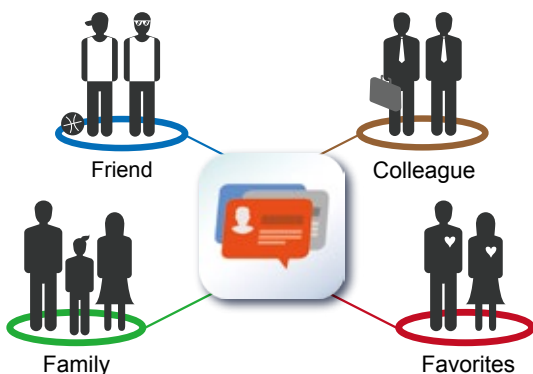

Use snapshots to backup and manage different versions of your contacts list

Snapshots of your contacts list can be taken at any time, and an unlimited number of version snapshots can be saved. In event of a crisis, you can restore a previous contacts list instantly.



More ways to enhance efficiency with Qcontactz

Streamline your entire email work flow with Qcontactz and QmailAgent

QmailAgent is an email application launched by QNAP. Qcontactz integrates with QmailAgent, automatically makes records of frequent contacts and automatically finds out recent contacts, and displays them in "Frequent contacts" column to the left of Qcontactz. You can also send emails to your contacts quickly by clicking on them in Qcontactz.

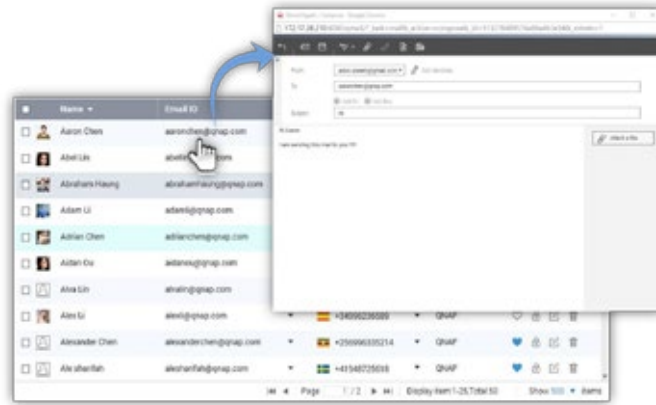

Provides a complete API file for easy integration with existing corporate CRM/ERP information

The Qcontactz API file is available to third-party applications as part of the system. To view the file, go to ":9090/api/v1/docs" in your web browser. Qcontactz can also be integrated with your existing corporate CRM/ERP database to provide a cross-platform and multi-terminal contacts management solution.



Mobile Qcontactz -- update your contacts through your mobile phone at anytime

Keeps your contacts information on your mobile phone updated at all times. With the Qcontactz mobile app you can import contacts from your mobile phone to your QNAP NAS in a snap. You can also set automatic synchronization with the NAS at a preset schedule.

✍ Supports: Android™ phones and iPhone.





Find files with one key stroke

Qsirch 3.0 fast global search

Photos, videos, music, documents, emails and other files can greatly accumulate on a NAS, making it difficult to search through and find desired files. Qsirch was created to provide a powerful search function that can easily sift through a huge number of NAS files and find desired files quickly. It not only checks indexed files and their contents, but is also perfectly integrated into QmailAgent to provide a powerful email search function.

Quickly finding desired message is now so simple

Qsirch is perfectly integrated into QmailAgent to provide a powerful email search function. You can set custom filtering criteria (such as: date, copy, sender, recipient, etc.), and quickly search through all the .eml format messages stored centrally on the QNAP NAS by QmailAgent. Even if you don't remember the date, sender and other information, just enter a keyword, and you will be able to find content that matches those keywords in email archives. You can also directly open archived emails and directly reply, forward or compose new emails*.

Qsirch combined with QmailAgent makes complex email search and management a breeze.

- 1 Install QmailAgent: Import your email accounts to the NAS.



- 2 Take advantage of Qsirch's Advanced Filters: use Qsirch's categorization to filter out emails. Enter the information you know about the message (such as: a travel plan for visiting Japan from a friend last month, you can enter the keyword "Japan travel" in the search box, then check the sender as a filter condition), and you will be able to quickly find the message. Compared to regular email applications that require you to manually enter the email sender, Qsirch makes it more convenient by actively presenting filtered results



- 3 Email search and management is well integrated: after Qsirch finds the message, you can directly open it to read its content, and directly reply to or forward the message through QmailAgent.



Proprietary technology, accurate search

Qsirch's full-text search engine supports over 6000 file formats. It also uses proprietary TF-IDF technology and automatic result recommendation system, so that when you are entering a keyword, you immediately see recommended results offered by the system, thus reducing the time spent in searching for files, and substantially increasing productivity. As soon as you enter Qsirch, you are immediately presented with a file distribution chart, laid out according to preset file formats such as images, music, videos, emails, documents and other types, allowing you to quickly understand search results. In addition to viewing by file type, you can also customize the presentation according to different conditions, such as file modification date, file size and other conditions to view the file.

More accurate searching with advanced search

You can use search operators to create keywords in Advanced Search and easily perform complex searches by setting up query range, time, file size, and other criteria, narrowing your search results to get more accurate search results.

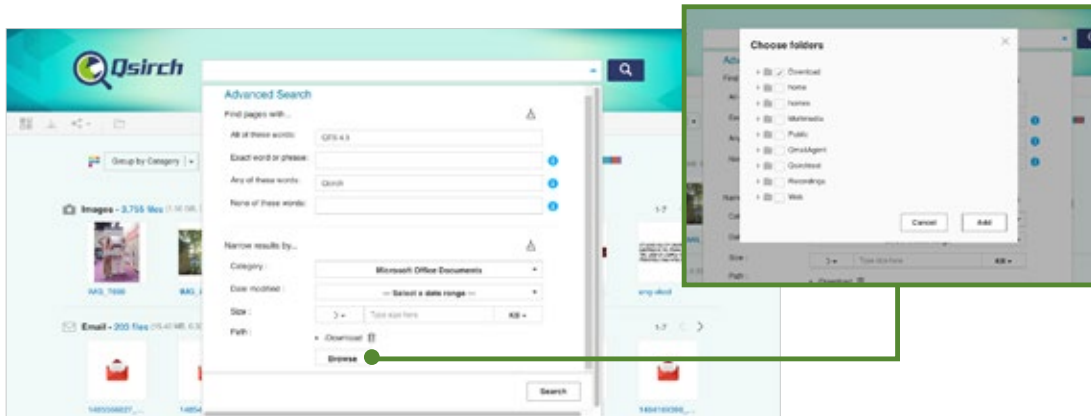

Increase search efficiency by customizing search filters

The new Flexible Custom Filter feature makes your search more accurate by providing unique filters based on the selected file type on the right side of the search results. Qsirch will scan all NAS data immediately according to the set criteria and quickly filter search results, and find critical files in a timely manner.

Exclusive filter conditions for various file types

Photos can be selected based on criteria such as camera model, focal length, lens information, IPTC keywords and shooting date; music files can be based on artist or album name; documents can be selected according to author; emails can be based on send date, recipients and other conditions.

Customize filters based on preference

Use the settings page to adjust filter conditions for each file category. You can also adjust the sorting criteria to move frequently-used conditions to the top, so that later, you will be able to set up filter conditions more effectively.

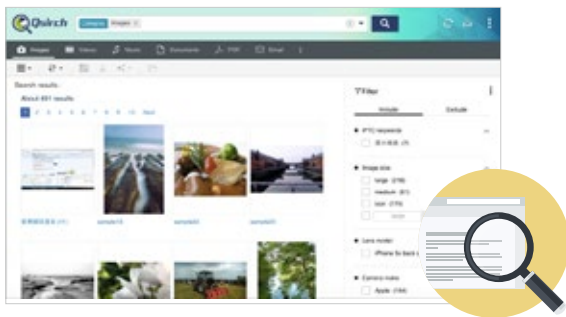

Freely switch between Inclusive / Exclusive filter conditions for the search

The filter provides two modes: Inclusive and Exclusive. You can choose a suitable mode according to the information you want to search. It also provides search fields to help you quickly find and check the filter criteria you want to add among hundreds of filter conditions.

Presented as tags for viewing at a glance

The filter criteria will appear above the search results page, so you can see all the selected filter conditions and delete any specified condition at any time from this block, and quickly adjust the filter criteria for the search results.

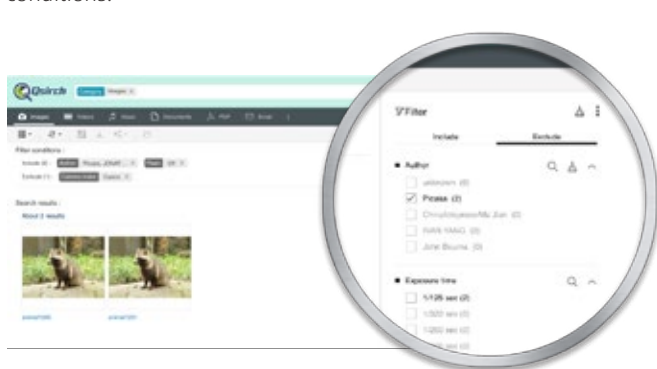

Instantly preview and easily share links

When searching for images, videos, emails, PDF and other files on Qsirch, simply click the file to preview its contents. This update brings a more powerful integrated file previewer that allows you to preview files in other formats (for example: Microsoft Word documents) in addition to multimedia files, emails and PDF files. Qsirch has integrated the cloud previewers Google Docs and Office Online, so that you can preview document content. In just a few steps, you can perform keyword search, content preview and file sharing all at once, drastically enhancing the user experience.

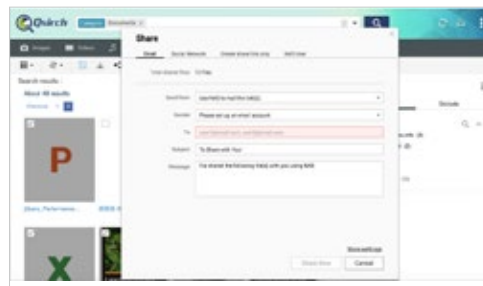
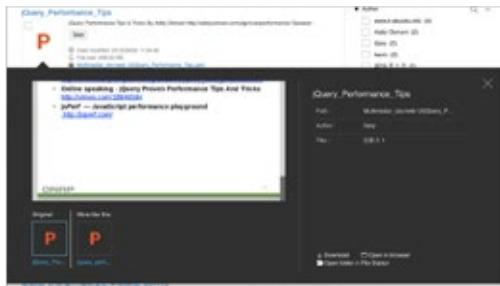

Smart relevant file recommendation

Qsirch's new relevant file recommendation feature enables you to find other files you may be interested in when you click to view the content of an archived file. It makes the recommendation in the browser page, and you can click the recommended file and switch the contents of the preview window to see if the file recommended by Qsirch is also what you wanted, thus reducing the time it takes to find files.



Folder indexing and search history management

Qsirch Helper is a Chrome™ Extension and Firefox Add-on. After installing it, you can click the Qsirch icon on the toolbar at any time to search for files on the QNAP NAS. It has now added a new QID login interface to allow you quickly complete the NAS connection settings. In addition, Qsirch Helper also supports Google synchronized search, so that every time you use Google search, it also synchronously searches for files on the NAS, and present the results to the right of Google search results. The instant search is fast and convenient.

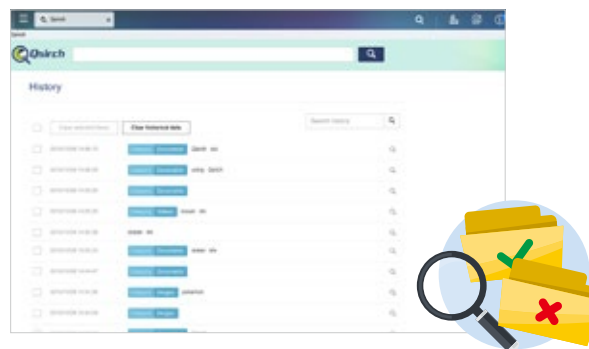

✍ Qsirch is suitable for all x86 and ARM models with at least 2GB RAM.

Special
column

Qsirch Assistant, instant search

Qsirch Helper is a Chrome™ Extension and Firefox Add-on. After installing it, you can click the Qsirch icon on the toolbar at any time to search for files on the QNAP NAS. It has now added a new QID login interface to allow you quickly complete the NAS connection settings. In addition, Qsirch Helper also supports Google synchronized search, so that every time you use Google search, it also synchronously searches for files on the NAS, and present the results to the right of Google search results. The instant search is fast and convenient.

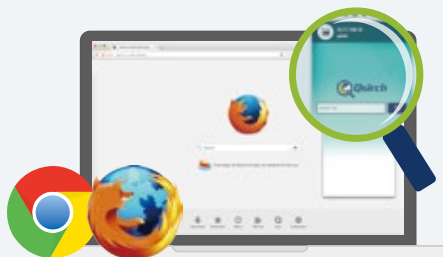

• Qsirch Helper (Chrome Extension)



• Supports simultaneous searching on Google®

Immediate mastery of Qsirch search techniques

Professors committed to academic research must read large numbers of papers and journals. When the professor becomes too busy and has no time to organize the articles, he might find it hard to find what he needs.

Workers in the wedding industry have to handle photos of dozens of new couples every day as their daily routine. How to effectively organize the photos and how to find a photo taken in a certain day from archived photos is also a big challenge for people working in the wedding industry.

Using QNAP NAS, you can not only easily store, backup and organize important documents, but also use Qsirch quick retrieval and filter to greatly improve efficiency.



Back up all important files via NAS

You can store important documents, data, media files and even emails in the QNAP private cloud. QNAP NAS provides the most secure environment for storing documents. At the same time, you can back up in the following manner:

1. By connecting to an external storage device through Thunderbolt, USB or eSATA, you can easily backup the shared files on the NAS to that device.
2. Instantly back up to a remote QNAP NAS or FTP server through RTRR (Real-Time Remote Replication) remote backup function or perform a scheduled backup to a remote rsync server using the sync protocol.

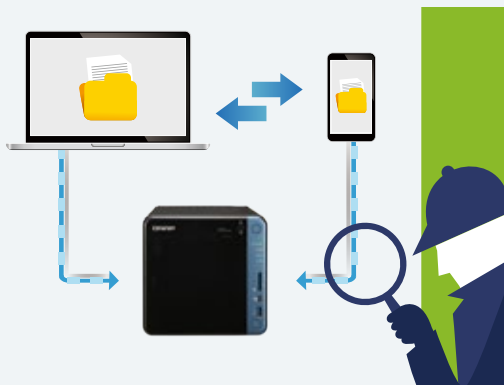

Make good use of filter conditions to search for media files and photos

It is usually not so intuitive to search for media files using keywords. To solve the problem, Qsirch provides exclusive filters for each file type (for example: shooting date, IPTC keyword, XMP, and more) so that you can find critical files in a timely manner.



File search with Advanced Search

Use search operators to create more accurate keywords in Advanced Search and easily perform complex search by setting up query range, time, file size, and other criteria, and narrow your search to get more accurate search results.

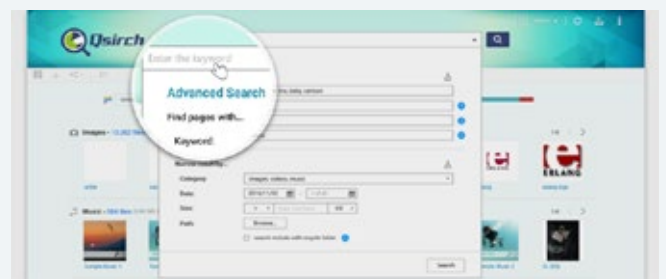

From email search to share, Qsirch is here to help

Qsirch provides a powerful email search function. Quickly search through all the .eml format messages stored on the QNAP NAS by QmailAgent. Directly open archived emails and directly reply, forward or compose new emails.





Revolutionize your perception of data Qfiling 1.0 Smart archiving

Organizing an ever-increasing collection of files and data that are distributed across a vast number of folders can be difficult and time consuming. With Qfiling's automatic filing feature and preset classification conditions, you can automatically organize and sort files.

Flexible Source Selection and Clean-up During File Transfer

Besides automatic organization of files on the local NAS, it also supports organizing files that meet specific criteria, copying files from external devices, iSCSI virtual disk volume or a remote NAS to the local NAS.

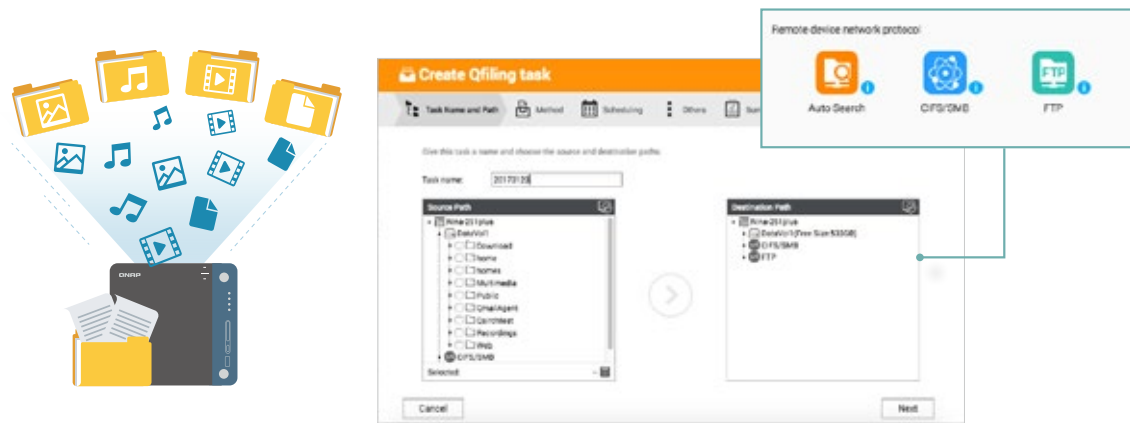

Set sorting conditions for rapid file organization

Qfiling works with selected types of frequently-accessed files such as images, music, videos, and documents. Simply set an automatic filing path, and you can rapidly transfer specific types of files to a designated target in separate folders. Advanced archiving conditions can also be set for each category, so that all kinds of files are archived in the most appropriate manner. Use the folder preview area in the overview page to confirm the archived file structure. Once you have confirmed that the conditions are met, you will be able to start archiving to instantly keep the system organized.

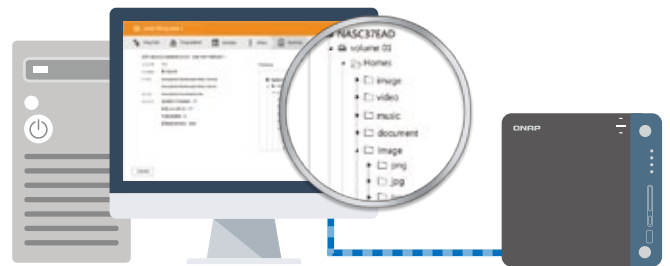

Photos

Organizing photos can be a chore. You can now customize the way your photos are organized by setting criteria such as: camera brand, camera model, shooting date, IPTC keywords, file extension, etc.



Music

Music files can be sorted and organized based on criteria such as album, artist, album artist, genre, year of publication, etc.



Video

Qfiling has an advanced video filing feature for filing videos with .srt subtitle files of the same name together.



Documents

PDF and Microsoft Office files can be sorted based on their authors. You can also sort documents based on their types, such as Word, PowerPoint, Excel, etc.

Schedule Background Batch Processing

Customize a schedule for performing automatic sorting and organization of your files in the background. Use checksums to ensure that the files are accurately moved from the source to the target.

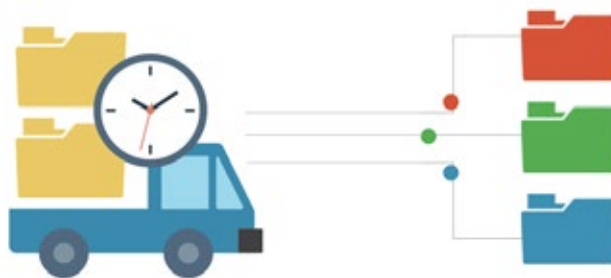

Recipe library stores commonly-used settings for quicker and easier filing

In addition to creating archiving tasks using the five-step process of "Custom Tasks", you can also select a saved recipe to complete settings. To help you quickly confirm your archiving conditions, Qfiling presents all the information on the same page. You just need to fine-tune the settings to create a new archiving task.





Featured recipe

Qfiling offers different recipes for different file types, including document assistant, music guru and video wizard and more. Through saved custom archive settings, it helps you understand the frequently-used conditions, so that you can quickly complete archiving task setup.

Exclusive recipe

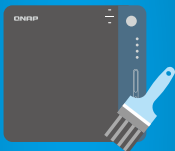
Once you become familiar with the filing operations, you can add frequently-used archiving conditions as exclusive recipes and store them in the recipe library, so that later on, you can set up an archive task in just a few seconds and execute the task immediately.



 <p>Automatically delete source files Effective use of NAS space</p>	 <p>Check whether the data is error-free Ensure data transmission integrity</p>	 <p>Smart archiving of video subtitles Move subtitle files while archiving</p>	 <p>Duplicate file name management Files from multiple sources are archived in one step</p>
---	--	--	--

To use Qfiling and its related features, download Qfiling and Qsirsch from the App Center.



Use VJBOD to optimize storage utilization

With QNAP's exclusive Virtual Disk Drive, administrators can flexibly expand the capacity of the QNAP NAS. Using an iSCSI initiator to connect to an iSCSI target on a QNAP NAS, administrators are able to create a virtual disk on a local server. QNAP's Virtual JBOD (VJBOD) also allows centralized management and allocation of unused space from multiple NAS on a single NAS.

For more information, see the VJBOD section

Special column

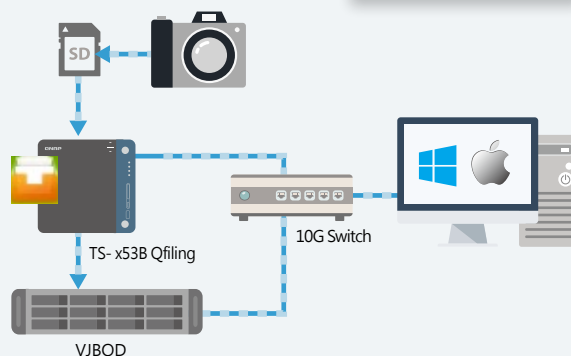

Foolproof data protection

Backup & storage space management

Perfect integration of public and private clouds

Hybrid Backup Sync Beta

Businesses increasingly warehouse huge volumes of data across disparate storage infrastructure, at disparate locations, and across disparate devices. This presents huge challenges to data management and storage. In response, QNAP offers a comprehensive backup and recovery solution to backup data to a QNAP NAS and to synchronize the data with remote NAS/servers and cloud services.

Centralized file storage and management

Hybrid Backup Sync is a comprehensive backup solution to efficiently manage storage space for all devices on the LAN, across remote-site NAS units and cloud services. QNAP NAS also supports backup from NAS to cloud storage while recording and encrypting all remote connections to accelerate remote-site or cloud backup tasks.



Local backup and synchronization

Hybrid Backup Sync allows you to back up your data locally without network connectivity. You can now back up your data to a folder on the NAS or an attached device for added data security without connecting to a network.

Backup to a local folder

By backing up and synchronizing the data on the QNAP NAS to other folders on the local machine, you can prevent files from being mistakenly overwritten or accidentally deleted.

Backup to an external device

Connect a USB device such as a camera, camcorder, or USB storage to the front-panel USB port and press the "Copy" button to instantly back up data to or from external USB devices.

Local backup and synchronization

- External devices
- Backup to a local folder

NAS to DAS

Remote backup and synchronization on the NAS:

- RTRR
- Rsync
- FTP
- CIFS/SMB

NAS to NAS

NAS cloud backup:

- Support for a variety of enterprise-class cloud storage

NAS to cloud

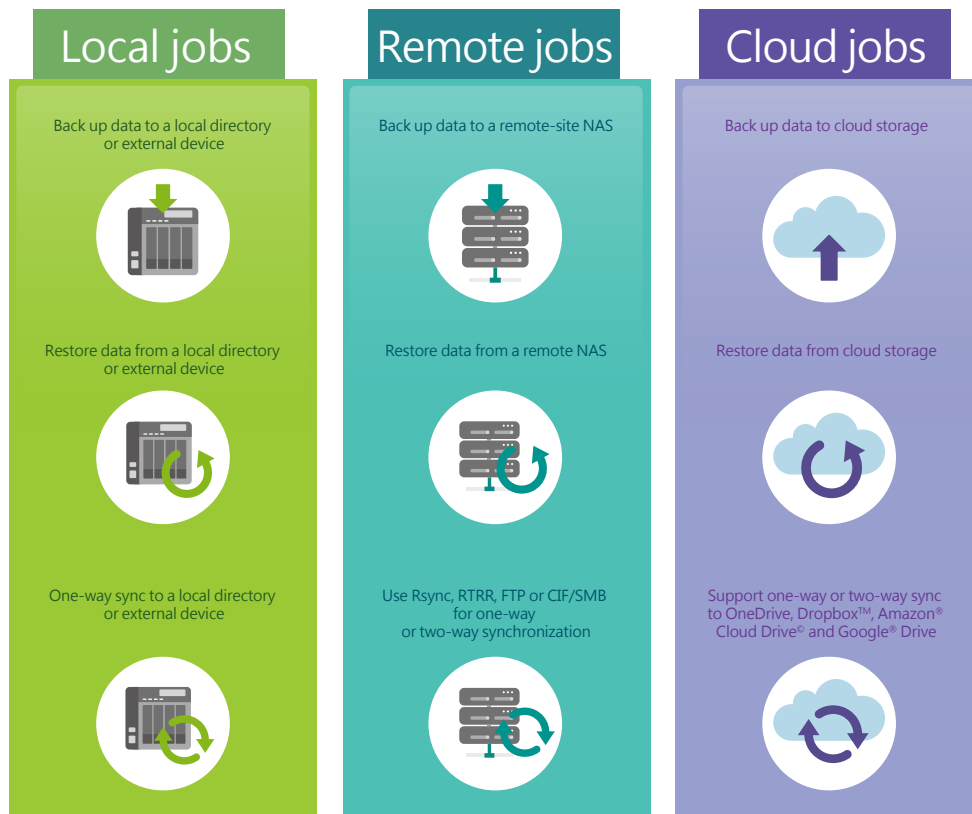

Remote-site backup

Your computer or NAS can be used as the source or destination, or as a relay server during the backup process. Through QNAP RTRR (Real-Time Remote Replication) technology or Rsync, you can easily backup data from your office to your NAS at home. Alternatively, you can use CIFS/SMB or a FTP service for RTRR in Hybrid Backup Sync.

Smart version control and recycling

RTRR allows saving of different time-based versions of backup files. In event of accidental overwriting, corruption, or deletion, your files can be restored to backed-up versions of specific times and dates. Smart versioning allows you to specify the number of hourly, daily, weekly, or monthly backups according to your recovery needs. Alternatively, you can use simple versioning to save a fixed number of versions of backup files over a given period of time, and automatically rotate saved versions.

Backup Monitoring

Hybrid Backup Sync lets administrators monitor backup jobs from remote servers. The administrator can monitor all backup statuses on a single NAS without logging in to the respective NAS.

Two-way shared folder synchronization

Use the RTRR service to set up real-time or scheduled synchronization of shared folders between two NAS. With two-way synchronization, file backup consistency is improved, which is especially useful in facilitating collaboration between departments and branch offices.



Cloud backup made simple



1 Compress

Hybrid Backup Sync supports compressed backups, scheduled file deletion according to user specifications, and sparse file detection to avoid backing up unnecessary files. Filter files by type, size, and date to ensure only required files are saved on the cloud for greater storage and cost efficiencies.



2 Select folder and encrypt

Hybrid Backup Sync features an SSL-secured connection and military-grade AES 256-bit data encryption to protect your data during transmission and storage on the cloud.

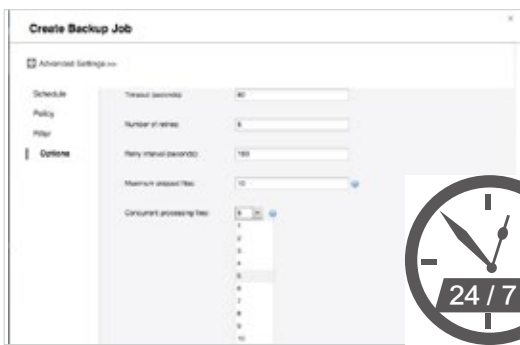

3 Multi-thread transmission

Hybrid Backup Sync supports multi-task processing and multi-threaded data transfers. This improves file transmission speed by segmenting large files into smaller ones before uploading. Users are able to preview files in the cloud and download individual files instead of the entire folder.

WebDAV app does not support multi-threaded data transfer.

Cloud backup and synchronization

QNAP integrates cloud services to allow you to back up data from your QNAP NAS to cloud storage in a real time or scheduled basis. Supported cloud services include Google Drive™, Microsoft® OneDrive® for Business, Dropbox®, Amazon® Drive, Yandex® Disk, Box®, hubiC®, Amazon® S3, Amazon® Glacier, Microsoft® Azure, Google® Cloud Storage, HiDrive®, Backblaze® B2, HKBN®, and cloud services compatible with S3, OpenStack Swift and WebDAV. Users can also download data to the NAS, allowing them to build a simple and affordable disaster recovery plan.



Backup from computer to NAS

Windows users can also install the free QNAP NetBak Replicator tool to back up files from Windows® to QNAP NAS. Mac users can use Time Machine to back up their files. A variety of other backup tools and software are also supported.



NetBak Replicator

QNAP's NetBak Replicator helps Windows users back up their documents, photos, music, videos, fonts, emails, and other files from their PC to one or more QNAP NAS. With a few clicks, you can set up real-time backup, scheduled backup and auto-backup. You can also set up automatic shut down after backup to conserve energy, filter unnecessary files, or set email notifications for completed backups.

Virtual backup server

As a secondary virtual backup solution, QNAP NAS is compatible with virtual servers such as VMware® ESXi server, Citrix® XenServer and Microsoft® Hyper-V, etc.

Third-party backup software

QNAP NAS are compatible with various renowned backup software such as Acronis® True Image, Symantec® Backup Exec. Users that have adopted such backup software can immediately back up data from other sources to the NAS.

QJBOD Express - fast data migration without a network

The new QJBOD Express enables rapid back up or migration of massive volumes of data to local or remote sites without using network bandwidth. The following example illustrates a data migration from a headquarters in Taipei to a branch office in Kaohsiung.

 The remote NAS must support JBOD expansion to use this feature.

Cost of migrating 50TB of data from Taipei to Kaohsiung.

Method	Time	Bandwidth cost
100Mbps network	About 45 days	50TB
QJBOD Express	In one day	0





Centralized Storage Management Storage Manager 4.3

The QTS Storage Manager neatly presents tools and options for managing system storage on an intuitive graphical interface. From reviewing the system storage allocation in the Dashboard, to managing volumes, Storage Pools, disks, and iSCSI storage, or even the new Snapshot function, Storage Manager provides a centralized place to simplify hard drive management and to maximize storage usage.

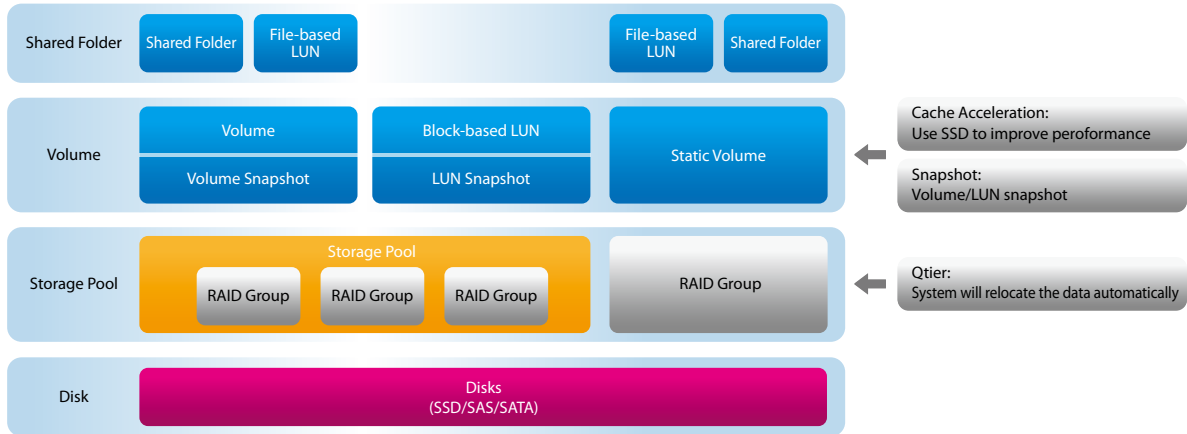

Storage Management

You can find all the information you need on storage devices, disks, storage space allocation and space utilization on the Storage Manager's newly-designed interface. Storage Manager is the best tool an administrator can have for managing storage spaces. It combines accessibility and usability by allowing storage pooling over multiple RAID groups, and replacement or expansion of online RAID groups.

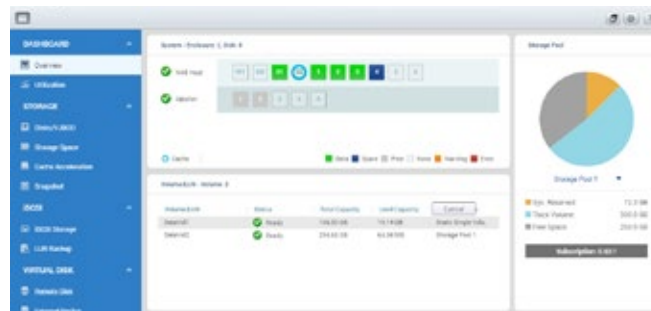

Volumes and Storage Pools

With the Storage Manager Setup Wizard, even average users can create, remove and expand new storage pools, set thresholds, manage RAID groups and select appropriate volumes. Enterprises can create different storage applications for different working groups. Furthermore, every volume and LUN disk space can be instantly expanded online without disrupting system operations.

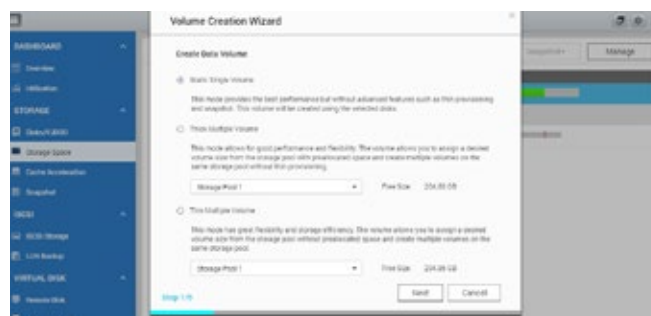

Choosing the Right Kind of Volume

Static Volume:

File access performance is optimized (about 20% higher than other disk volumes). Despite not having advanced features such as snapshots, this option is suitable for creating high-performance storage spaces for file sharing or online collaboration.

Thick Volume

Physical storage capacity is dedicated during the initial allocation of the storage volume. If your NAS supports this type of volume, you will be able to protect your data with snapshots. This mode is suitable for general storage.

Thin Volume

Over-allocation enables a server to view more storage capacity than has been allocated in a storage pool. Furthermore, physical storage capacity is used only when files are being written. Thin provisioning allows more efficient use of storage space, and is useful for dynamic storage spaces and when there's a need for multi-person storage space allocation.



You can pre-allocate all the required storage spaces such that they cannot be used by other volumes of LUNs.

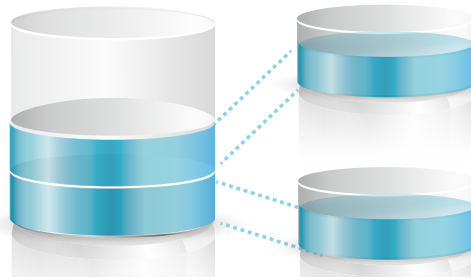

Space usage is more flexible since only the space that is actually used is calculated.

Two types of iSCSI LUNs

Block-Level

Block-level LUNs created on storage pools not only facilitate storage space management, they also support advanced settings such as Windows ODX and VAAI for effective utilization in virtual environments and multi-LUN spaces.

File-Level

File-level LUNs created on volumes are good for system caching. They are especially useful for inadequate disk performance, or when you need to share your NAS space with other devices in small-to-medium environments.

Virtual Disk Drives increase expansion flexibility

With QNAP's exclusive Virtual Disk Drive, administrators can flexibly expand the capacity of the QNAP NAS. By using an iSCSI initiator to connect to an iSCSI target on a QNAP NAS, administrators are able to create a virtual disk on a local server. QNAP's new Virtual JBOD (VJBOD) allows centralized management and allocation of unused space from multiple NAS on a single NAS.

 For more information, see the VJBOD section

Disk Management and Migration

Storage Manager is equipped with a wide array of disk management technologies. Besides basic online RAID expansion (add disks) and replacement (replace a disk with one that has larger capacity), it also supports RAID and storage pool migration. After uninstalling a storage pool from the NAS safely, a hard drive can be removed from one NAS and inserted into another, without affecting the data it contains. This feature is a great help for IT personnel planning for storage expansion, replacing old NAS, and emergency data restoration.

Automatically detects disk order

You do not need to worry about getting the order wrong when you reinsert the disks during maintenance. Storage Manager has a protective mechanism that automatically detects disk order. Even if the disks are rearranged when the system is powered off, Storage Manager is able to detect the correct RAID order and access data normally after the system is powered up. This reduces the risk of data loss due to human error.





Well-rounded data protection Snapshot

QNAP Snapshot technology lets you recover a single file, multiple files or folders, and even the entire volume to a designated point in time in case of accidental deletion or modification. It is a great tool for meeting enterprise requirements on achieving Recovery Point Objectives (RPO) and Recovery Time Objectives (RTO).

✍ Snapshot is only available for certain models and requires a minimum of 4GB memory.

Remote Backup and Restore

Besides taking snapshots of and recovering specified files, folders or iSCSI LUNs, QNAP's Snapshot technology lets you snapshot the entire volume, and supports duplication of the specified files to different directories. Not only can you backup and restore multiple versions of your volume and iSCSI in the local NAS and expansion device, you can also store the snapshots in a remote QNAP NAS. This ensures that your precious data remain safe even in a disaster.

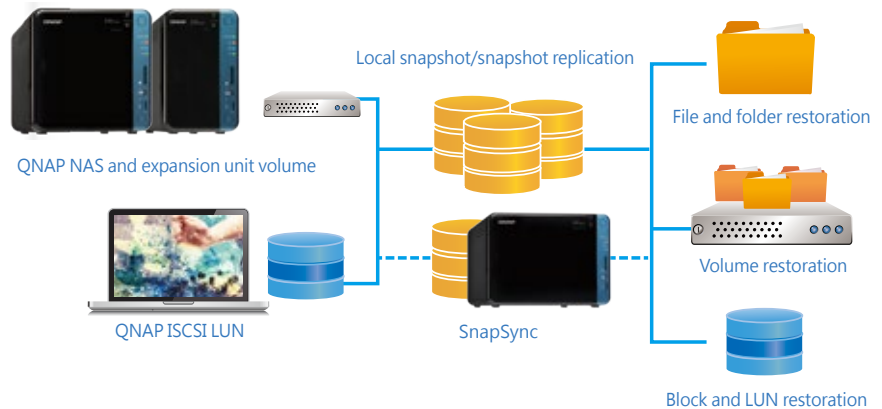

Block-based snapshot ransomware protection

QNAP snapshot technology is Block-based. By indicating the backup file revision and saving the revision separately in the file system, you not only effectively reduce backup space and restore time, but also protect snapshots from damage by ransomware and other computer viruses. Through 256 snapshots of each volume or LUN with QNAP NAS, you can fully and efficiently protect your NAS.

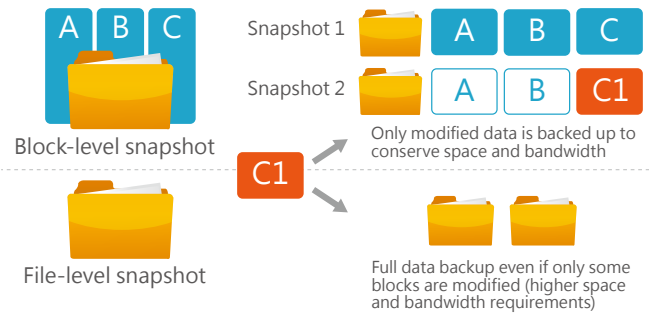

Application-consistent Snapshots with QNAP Snapshot Agent

QNAP Snapshot Agent (used for iSCSI LUN) enables connecting a QNAP NAS to remote servers (VMware vCenter™ or Windows Server®) to ensure consistent snapshots. On those remote servers, running applications (VMware® virtual machines, Hyper-V® virtual machines) will write/flush the data from the memory to the iSCSI LUN prior to the snapshot being taken. The application will then be consistent and will include all necessary data. In case of snapshot restoration, no data will be missing.

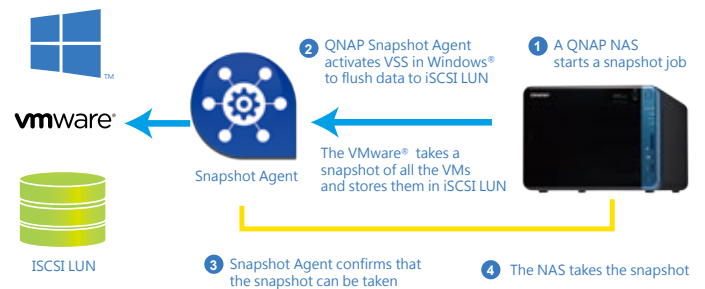

Local Snapshot

Multiple version control and quick response to remote end

NAS administrators can view snapshots that are manually taken or retrieved according to schedule. Snapshot contents can be quickly restored in their entirety to the local NAS, or restored on a folder/file basis to local or remote NAS.

VMware®/Microsoft VSS integration

QNAP snapshot supports VMware® / Microsoft® VSS storage interface. When QNAP NAS makes a backup, QNAP Snapshot will notify VMware® / Microsoft® VSS through Snapshot Agent to stop its scheduled tasks and automatically forward locally mounted iSCSI LUN to QNAP NAS to perform snapshots and storage tasks. This ensures data integrity and reduces system overhead.





automatic tiered storage system

Qtier™ 2.0 - enable smart data sensing

Qtier™ Technology empowers automated-tiering storage solutions that automatically moves frequently-accessed “hot” data to high-performance storage tiers and infrequently-accessed “cold” data to lower-cost, higher-capacity drives. This allows businesses to enjoy both exceptional application performance and lower TCO of storage. System performance and storage space usage efficiency are enhanced at the same time. This is no doubt the best storage solution for virtual applications with rapidly changing data processing loads.

IntelliSense, Auto Tiering

As the price of solid-state drives (SSD) becomes more favorable, the demand for high-performance storage increases. With the advantages of high IOPS and low response times, SSDs improve the performance of data center applications that require fast and consistent performance (such as databases). However, the average cost of SSD per GB is still higher than traditional HDD, so it is expensive to deploy a full-SSD storage solution.

Qtier™ is a hierarchical storage architecture management system that automatically moves frequently-accessed blocks to high-order disk tiers (from HDD RAID groups to SSD RAID groups), and move infrequently-accessed data to low-cost, high-capacity HDD RAID groups. This mechanism can significantly reduce the burden on storage efficiency assessment, configuration design, data migration and ROI management, and at the same time, make the most effective use of SSD by eliminating the need for manually differentiating between “hot” and “cold” data to different tiers, thus improving the performance of storage devices for frequently-accessed data.

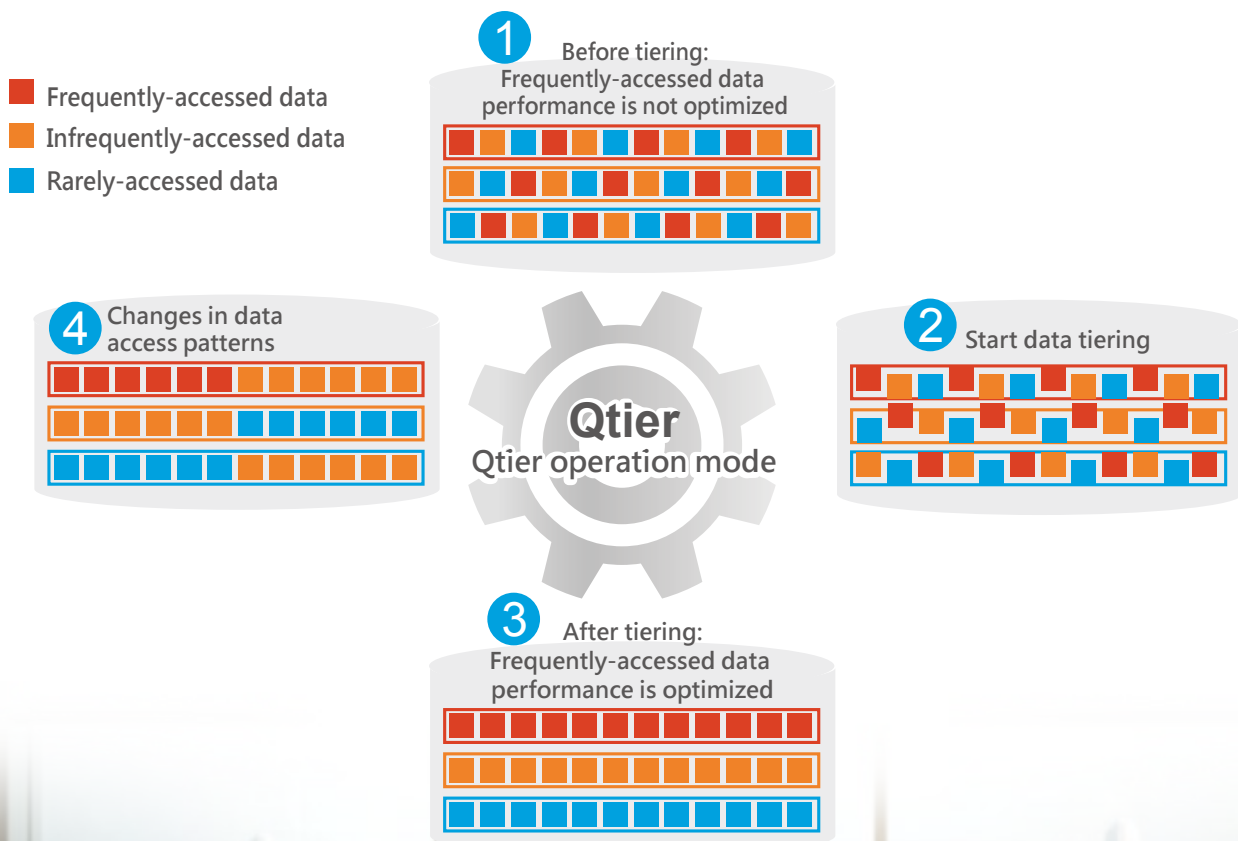

Answers your demands for storage efficiency

Based on the storage needs of enterprise users, Qtier™ technology can create hierarchical disk groups according to SSD and HDD, and the system will automatically differentiate between “hot” and “cold” data to the corresponding tier. This configuration is best suited for use in fixed-access mode, event-triggered applications. IT staff can use this system to allow files, websites, email servers or commonly-used virtual desktops with high-speed access needs to automatically enjoy high-speed SSD benefits, while the remaining files can be automatically stored to large capacity HDD. Build an effective hybrid storage array for your data center at low cost.

Configuration method	Qtier™ 2.0	Full SSD	Full HDD + cache	Full HDD
Investment costs	\$\$	\$\$\$	\$\$	\$
Storage performance	★★★	★★★	★★	★
Storage Space	Large	Small	Large	Large
SSD expansion mode	RAID Group Expansion	RAID Group Expansion	Limited to memory and local slots	No
Data migration mechanism	Instant migration based on usage frequency	All stored in SSD	Replicates frequently-accessed data to SSD	All stored in HDD
Applications	When applications need high performance but has a fixed access mode. Such as archives, web pages and online streaming, email servers, and VDI environments.	When all applications need high performance. Such as database or high-speed virtualization applications.	When only specific data is repetitively and frequently used. Such as virtualization and online collaboration.	When data requires prolonged writes without needing quick access. Such as backup or storage monitoring.

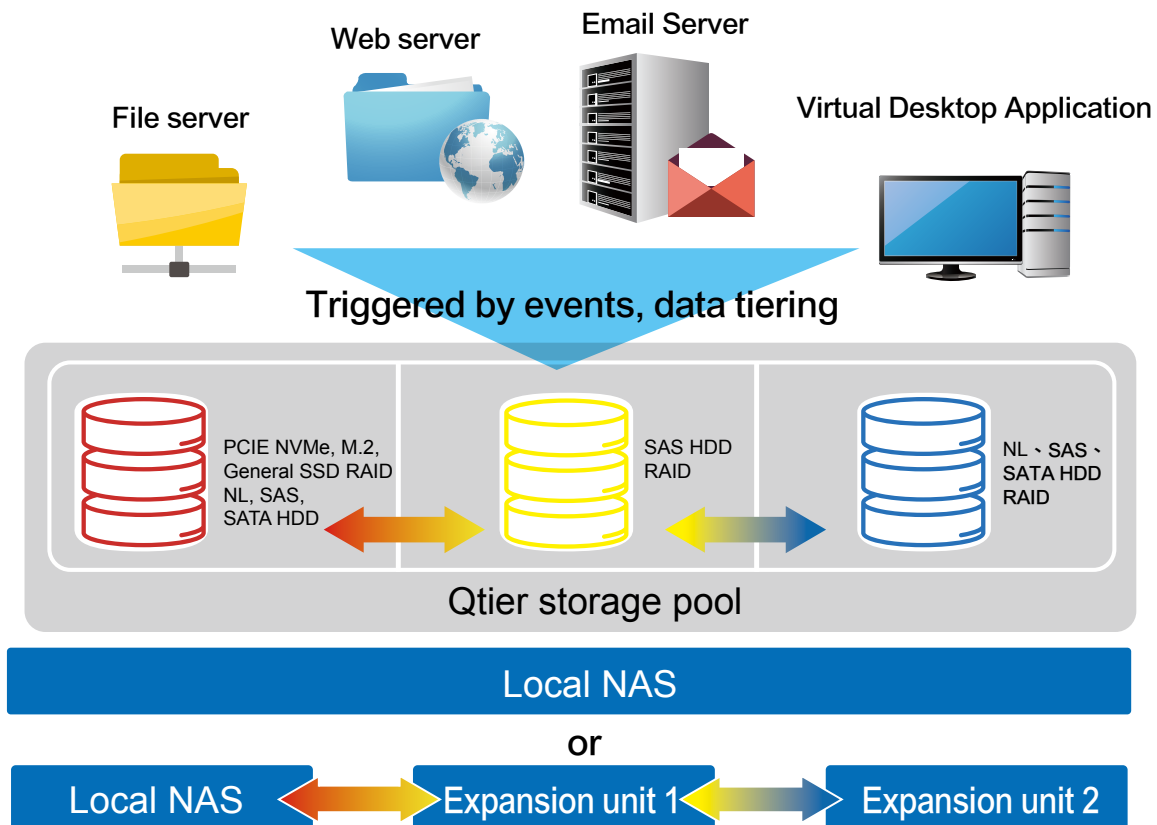

On-Demand Qtier™ 2.0

Based on the positive feedback to Qtier™ from IT professionals, QNAP further enhances hardware and software support in Qtier™ 2.0 for on-demand setup with different settings and build a storage system applicable to various scenarios.

✎ Upgrading to a Qtier pool is only available on QTS 4.3.4 or later.

Add an SSD to upgrade a HDD Pool to a Qtier Pool

From QTS 4.3, Qtier™ is available for more QNAP NAS, including small business NAS in addition to rack-based enterprise NAS. Whether you have chosen Qtier or not when creating a storage pool, you can always add a general storage pool to your new storage tier by inserting an SSD, a QM.2 expansion card, or an optional expansion unit and immediately use Qtier.

Easily upgrade and enable Qtier™ in three steps:

1. In the Storage Pool Management page, open Storage Manager, and choose Extend > Upgrade to Qtier.
2. Select the SSD or HDD group you want to add.
3. Confirm the settings and start the upgrade.

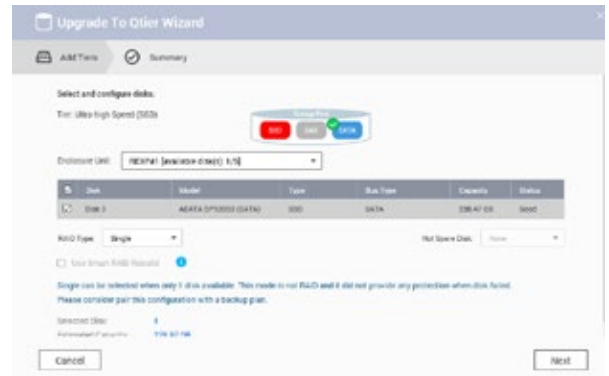

Using Qtier and SSD cache in conjunction for accelerated cache access in multi-tasking environment

With Qtier™'s latest automatic scheduling capabilities, Qtier 2.0 can also be used in conjunction with SSD caching. In this mode, not only can data in the SSD tier be quickly accessed, even in the HDD tier, data can also be accessed quickly via accelerated read from the cache. Using this architecture, the SSD tier accelerates read speeds that requires stable access, while SSD caching is complementary to Qtier™.

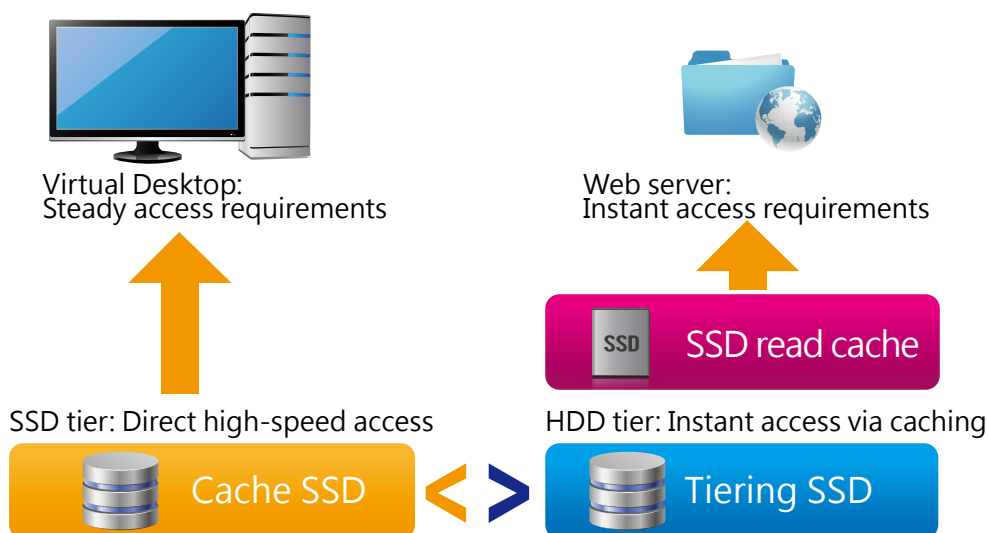

Set up on-demand Qtier™ automatic assignment priority for shared folders

In the past, even if a storage-pool-based Qtier™ can stratify “hot” and “cold” data, it is still possible that the access performance for critical data and applications are not enhanced through the use of SSD due to mass storage of unimportant data.

On-demand Qtier™ 2.0 shows QNAP's effort in pursuing maximum return on investment for customers again. By setting up on-demand priority for a folder manually, NAS administrators will have the right to decide which data for each folder should be preferred to move to a specified tier.

This data-adjusted storage tier architecture allows users to precisely adjust the performance of the most critical data based on the amount of data in the NAS and the amount of SSD they invest. In a limited SSD storage space, Qtier™ not only adds more flexibility, but also maximizes the return on SSD investment.

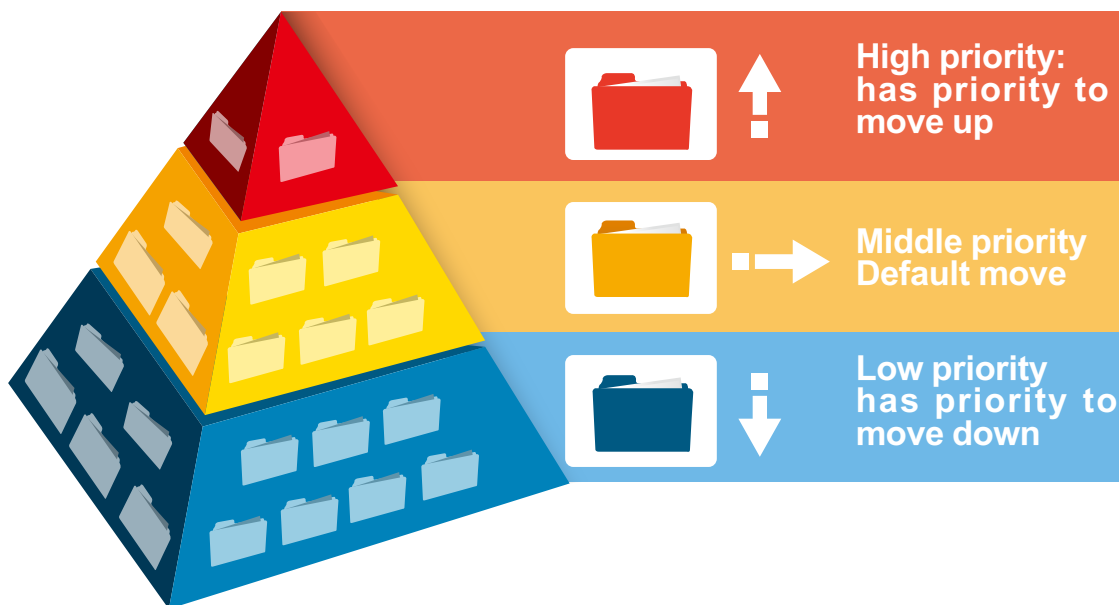
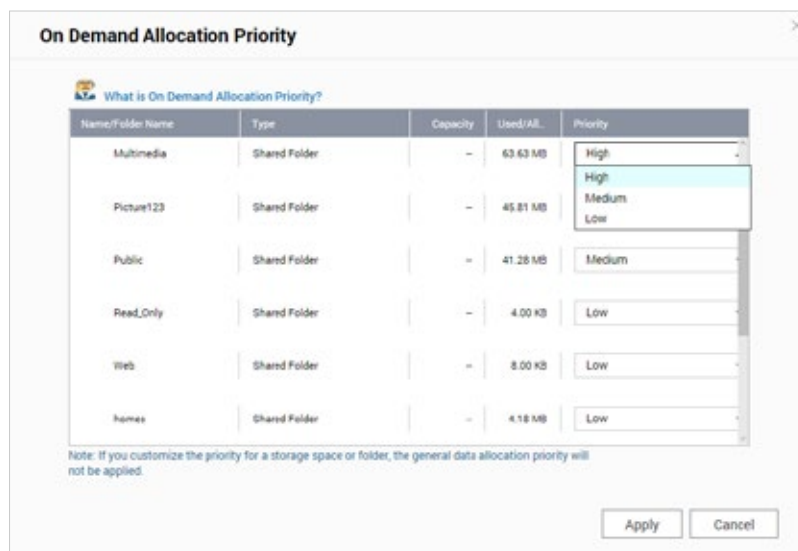

Comparison table	Qtier™	On-demand Qtier™ 2.0
Enable Qtier	Setup required when creating a storage pool	In addition to using Qtier™ when creating a storage pool, you can also use the Qtier™ upgrade program to build on top of general storage pool by installing an SSD, QM2 M.2 SSD expansion card, external storage expansion unit and other devices to integrate as Qtier™ storage pool. *
Tiering schedule	Manually set up tiering schedule.	Automatic scheduling with SSD cache, 24-hour adjustment of system performance.
Tiering mechanism	Tiering according to data-access frequency.	Tiering according to the data-access frequency and shared folder designated by user.

*When you use Qtier™ to upgrade a storage pool, storage-related services still need to be temporarily suspended.

Benefits of using Qtier Technology



Optical storage efficiency

Data can be flexibly migrated across high-performance SSD and high-capacity SATA disks based on access frequency. Storage efficiency is continuously optimized during system idle time, and data optimization can be completed before peak system usage times.



High performance access

Overall system performance is improved as active data is moved to faster storage tiers for standby.



Automatic optimization or manual scheduling

QTS 4.3's automatic scheduling can determine the appropriate time for data transfer according to storage pool operating efficiency. This feature runs uninterrupted all day long.



Easy to set up

Use the QTS Storage Manager to create RAID groups for each tier, set the required scheduling, and it's done.



Cost saving

By buying only the SSDs that are needed, businesses can save money on expensive Flash technology.



Performance analysis

Check history reports for Auto Tiering statistics to evaluate the accuracy of auto-tiering policies

You can easily implement a 2-tier or 3-tier storage solution with a JBOD

Are you troubled over increasing data storage needs as a growing business? To tackle the increasing data needs of a growing business, the scalable TS-1685 supports online capacity expansion by connecting up to 4 QNAP RAID expansion enclosures (REXP-1000 Pro) to flexibly expand the total storage to over 1 PB raw capacity (depending on model). It saves businesses from huge investments at initial setup, and provides budget-friendly options for a range of IT budgets.



QNAP Auto-tiering management architecture

Auto-tiering is carried out at the block level, and will be done with normal I/O segment protection, and will not interfere with each other. Administrators need not worry about data inconsistency in automatic tiering. As for data migration management, in addition to setting manual or automated schedules, managers can also specify data migration priority tiers and the percentage of data that needs to be retained in the SSD tier. In all cases, the use of SSD can be adjusted according to needs. Finally, managers are able to view the history of data tiers at all times in Storage Manager, and understand the operational status of the Qtier™ as well as complete tiered data migration record.

Qtier™ management interface

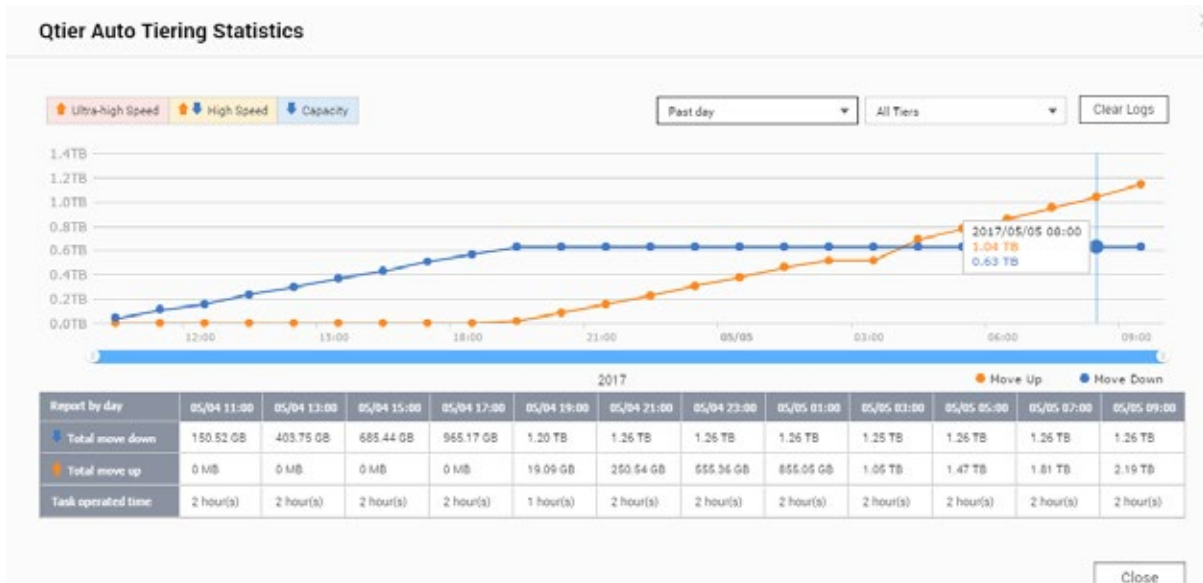

Qtier™ tier activity statistics report

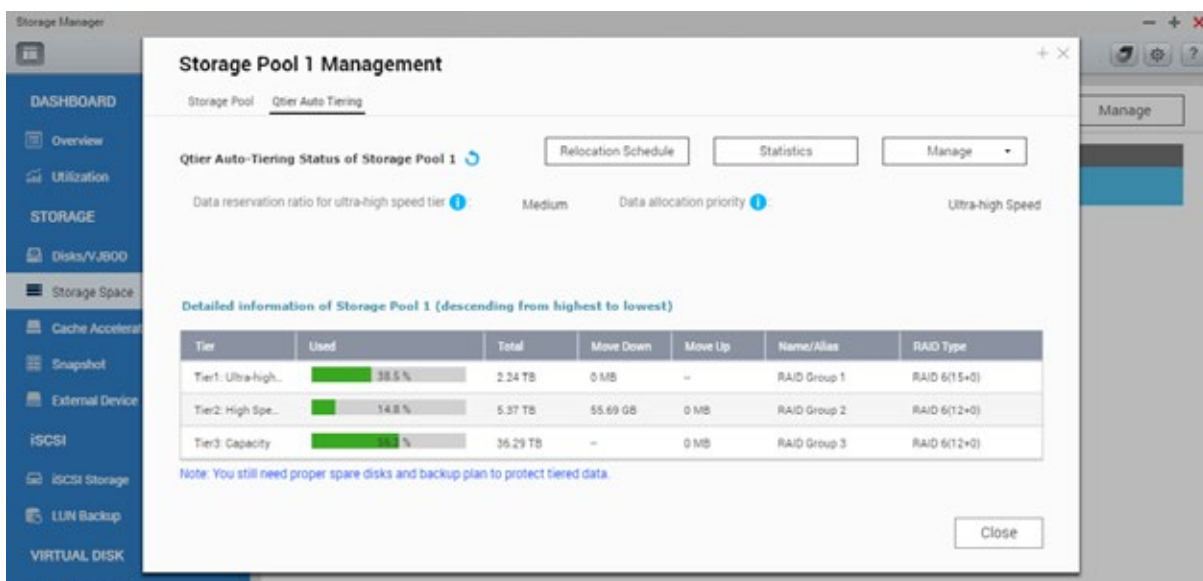

VJBOD Flexible and economic use of storage space through sharing

Virtual JBOD

When I have multiple QNAP NAS units, or when I need to expand capacity on-demand, how do I achieve the best NAS storage utilization? With QNAP VJBOD (Virtual JBOD), you can interconnect the idle storage space on the local NAS and other compatible QNAP NAS, and create a virtual storage pool or JBOD on the local NAS. Maximize the usage efficiency of each NAS through sharing

On-demand, instant storage capacity allocation

Use QNAP VJBOD to instantly allocate storage space from another QNAP NAS as an iSCSI LUN. Then use the iSCSI LUN to create storage pools, take snapshots, make a clone from snapshots or index multimedia files into the media library on the local NAS. VJBOD redefines storage space architecture using appropriate software, such that even small to medium businesses can make use of this new technology.

Expand storage capacity remotely

As long as the remote QNAP NAS supports iSCSI services and storage pool settings, it can be added into the VJBOD*. For example, a TVS-882 connected with four UX-800P expansion units can have approximately 300TB raw storage capacity in total (calculated using 8TB HDDs). The capacity can also be easily expanded up to 1PB using QNAP VJBOD**.

*Remote QNAP NAS must support iSCSI service and storage pools, and its firmware must be QTS 4.2.1 (or later). Supports up to 8 remote NAS.

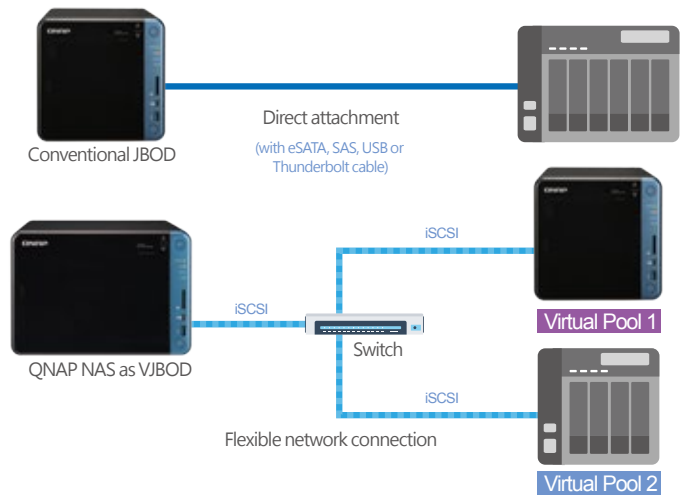

Intuitive and easy-to-use interface

No complicated commands or procedures are needed to set up Virtual JBOD. Take two connected QNAP NAS, click "Virtual JBOD" in Storage Manager in QTS. Then follow the "Create Virtual Disk" wizard to search for the second NAS. After confirming usable space, the iSCSI LUN will be created, and the space will be converted to a virtual drive on this machine. Then freely utilize and manage this virtual disk in Storage Manager, including checking the status and network location of the virtual disk.



High-performance VJBOD storage with super-fast 40GbE and 10GbE

VJBOD offers greater flexibility with online capacity expansion over traditional JBOD expansion. In a data center environment where transmission speed is a priority, you can leverage 10GbE or even 40GbE network expansion cards and switches, it also works for data transfer between local LUNs and virtual LUNs.

Deploying Windows Offloaded Data Transfer (ODX) on Windows Server to directly transfer data within or between virtual disks and compatible expansion units, and bypassing the host computer, brings further performance benefits.

	VJBOD	JBOD
Connection Interface	Ethernet (1GbE, 10GbE, or 40GbE)	USB 3.0, SAS 6G/12G
No. of Connections	8 Virtual JBOD (Multiple hard drives can be set up for a single NAS)	1 to 8 (depending on the NAS model)
Connection Method	Ethernet	Single connection or daisy-chained
Backup Connection	Supported (Port Trunking)	Not Supported
Application Scenario	Multiple QNAP NAS units offering the flexibility in storage utilization while maintaining the highest availability	It can be used to expand local storage pools on a single QNAP NAS.

Virtual JBOD does not currently support directly expanding a local storage pool.

Redundant network architecture to increase reliability of VJBOD

Online capacity expansion over a network does not cause an associated instability of storage space utilization. QNAP NAS equipped with two or more Ethernet ports support port trunking (link aggregation with multiple LAN ports). Port trunking increases the bandwidth of your NAS and provides fail-safe traffic to maintain connectivity in the case of a connection failure. With port trunking, network traffic will also automatically achieve load balancing for each connected device.

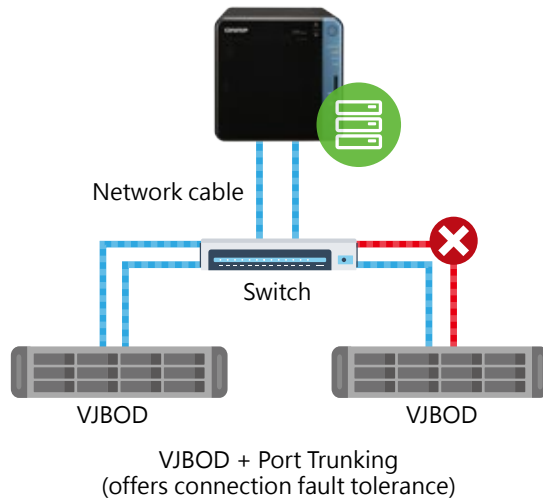

Automatic VJBOD storage recovery after auto-reconnection

Your data's integrity is protected by both the disconnection protection mode in QNAP NAS and disconnection protection mechanism of the VJBOD. If the remote NAS encounters a power outage or change in IP address, you will get warnings via event notifications in QTS. The NAS will also automatically try to reconnect and recover the VJBOD storage.

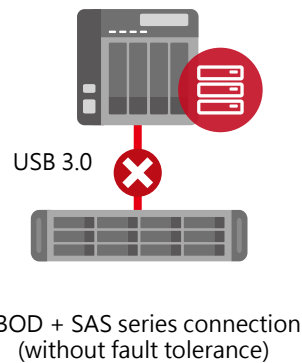

Instant migration of VJBOD without physical plugging and unplugging

Typically, to migrate an expansion unit requires manually unplugging the device, transporting it to the destination and plugging it in. However, VJBOD enables connection using iSCSI and can be safely detached as a storage pool in Storage Manager. Virtual disks that have been detached from your NAS can immediately be used again on other NAS making the data and applications on virtual disks accessible to be shared among different QNAP NAS. This makes it incredibly easy to transfer large amounts of data, applications and LUNs from one NAS to another.

✂ Virtual disks that have been connected via iSCSI targets to be used in Virtual JBOD should be excluded from other iSCSI initiator connections.

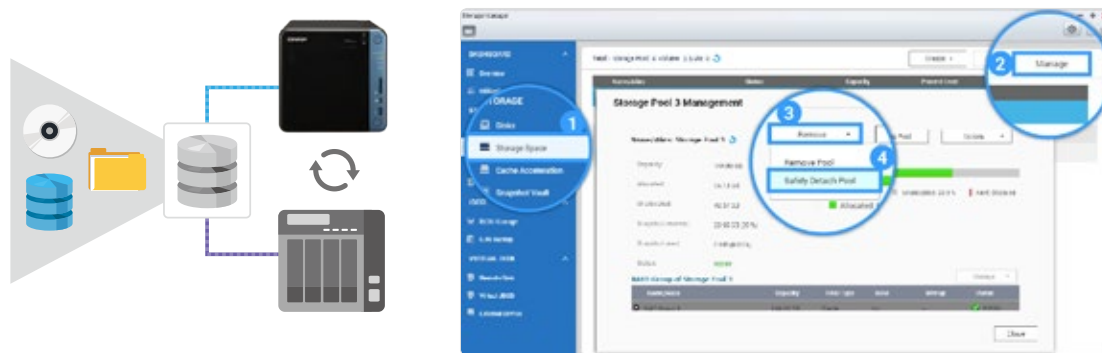

Monitor device connection status with Virtual JBOD Overview

QNAP NAS provides management and monitoring functions enabling administrators to obtain the most up-to-date information on connected VJBOD. You can also use the iSCSI connection page on the remote NAS to check what NAS is currently using the Virtual JBOD function. Furthermore, with the independent system on the remote NAS, if the host NAS is down and the connection log is inaccessible, you can still access the remote NAS to view logs and records for easy troubleshooting.

Pool Name	Status	Pool Size	Pool Storage Pool	Pool Network/Port	Remote NAS	Remote Storage Pool	Remote Pool Description	Remote Network/Port	Mount
VJBOD 1	Ready	700 GB	Storage Pool 1	eth0	Remote NAS	Storage Pool 1	Remote Storage Pool	Remote NAS	Enabled
VJBOD 2	Ready	3.42 TB	Storage Pool 2	eth0	Remote NAS	Storage Pool 1	Remote Storage Pool	Remote NAS	Enabled
VJBOD 3	Ready	800 GB	Storage Pool 3	eth0	Remote NAS	Storage Pool 1	Remote Storage Pool	Remote NAS	Enabled
VJBOD 4	Ready	200 GB	Storage Pool 4	eth0	Remote NAS	Storage Pool 1	Remote Storage Pool	Remote NAS	Enabled

✂ The Q'center app offers more convenient tools for you to monitor the status of remote NAS.

Fast connection to NAS and file synchronization across devices

File synchronization and remote access



Instant synchronization of important files with the NAS

Qsync Central 3.0

With recent advancements, users and IT administrators may not be satisfied with traditional ways of backing up photos, videos and important files. Current backup methods are unable to provide instant access across multiple devices, and can be difficult to set up. Qsync Central is an easy-to-use private cloud for storing and synchronizing large volumes of personal, business and organization data across multiple devices. Qsync provides a complete file sync solution that helps businesses and organizations ensure that team members always have the most up-to-date files for greater work efficiency.

Browse your files on different platforms and devices

Qsync Central supports file synchronization across multiple devices. You can browse synchronized files on mobile devices, computers or on a webpage. If your computer is offline, you can view/edit files in the local Qsync folder. When Internet connectivity resumes, Qsync will continue data synchronization. With personalized synchronization settings, you can choose to permanently retain the files on the QNAP NAS, conserving storage space on local devices.

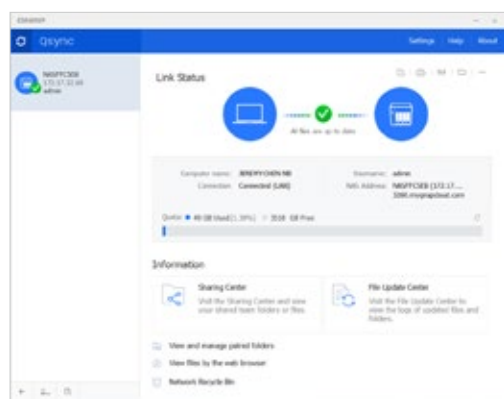

Start using Qsync immediately

Qsync Client's easy-to-use interface comes with a number of handy and practical features that allow you to create download links, share files through the computer's email server, perform connection speed testing, and troubleshoot connection problems. With Qsync Client, managing all tasks is a breeze.

✍ Qsync Client supports Windows® and Mac® and allows synchronization across multiple computers.

Supports shared folder synchronization across multiple NAS for seamless file sharing

Qsync supports synchronization across multiple NAS, allowing users to share files freely with anyone with a QNAP NAS, or synchronize files with your business partners to facilitate better collaboration. You can also synchronize multiple shared folders on the QNAP NAS with your computer's Qsync Client.

✍ Synchronization across multiple NAS is currently only supported by Windows.



Share team folders to improve collaboration and team work efficiency

Ensuring consistency of materials used throughout workplaces is a priority in teams and departments. Qsync allows you to build an environment for greater collaboration and teamwork. Simply create a sub-folder in Qsync folder, configure some simple settings on your device or NAS, and you can share the sub-folder with different groups of NAS users so that every group will have the latest files.

Control your device settings for simpler management

By creating default settings in Qsync Central and applying them to Qsync clients, you do not need to set up individual clients separately. Administrators can also monitor user settings through the central management system, strengthening enterprise-wide IT management and file filtering control, and eliminating the risk of accidentally deleting files on a QNAP NAS during synchronization. Through using different permissions settings on each device, administrators can also customize the management of individual devices. In addition to the above, Qsync Central also offers flexibility and convenience in centralized management.

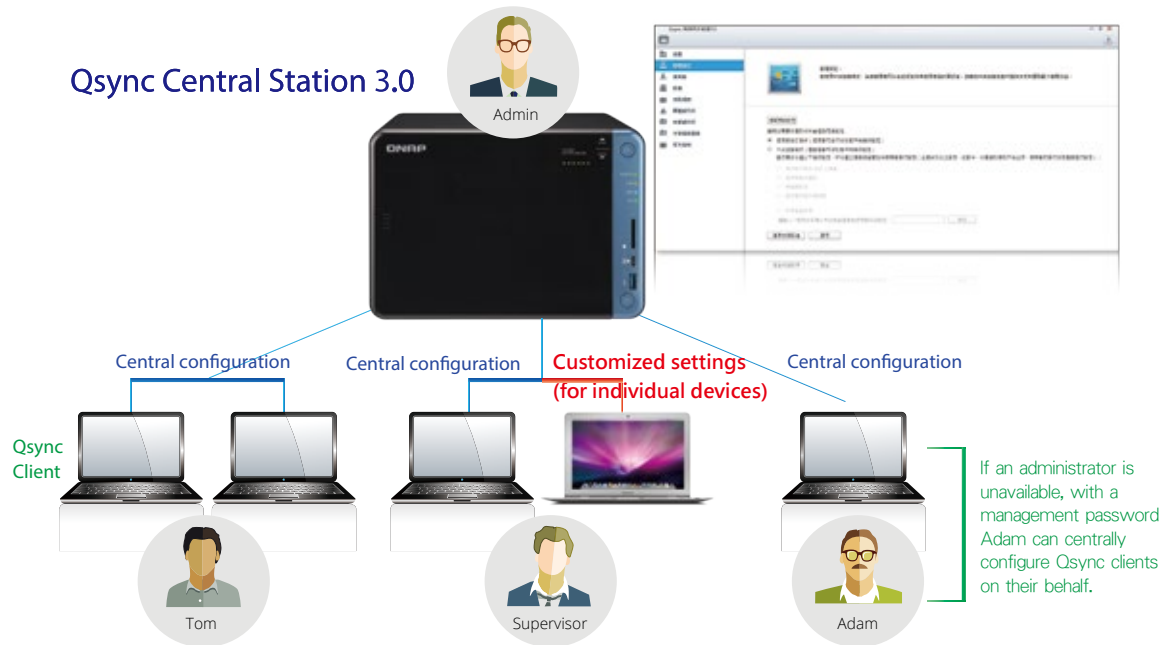

Protecting your data carefully with remote wipe and version control

What will happen to your private or confidential files in your Qsync folders if your device is lost? Lost or stolen devices can have their Qsync folder remotely erased to ensure that sensitive or confidential data is not accessed by unauthorized users or leaked. When the device is recovered, Qsync can easily restore the data that was deleted once it's connected, providing the perfect balance between security and convenience.

✍ The data will still be retained on the QNAP NAS after remote wipe.



Give your business an edge with system self-recovery

Your database may be accidentally damaged by careless operations or NAS hardware failures. The time required to troubleshoot and repair the system may result in losses for your business. The new self-detection and restoration feature in Qsync Central can help reduce the incidence of errors, increase system reliability and reduce the risk of accidental data loss.



Qsync Client

Qsync Client displays all statuses in the simplest and most intuitive manner.

A convenient helper for detecting connection problems

In event of connection problems, the helper can help detect problems with the NAS and devices. You can also monitor transmission rates during normal connections. Even non IT-savvy users can locate the source of connection problems.

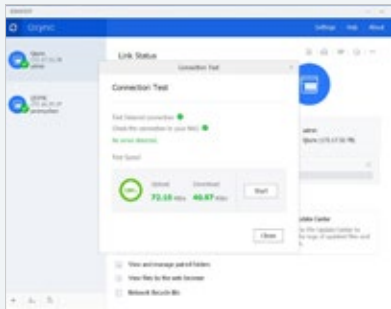

Selective synchronization

You can choose the type of file or sub-folder on the NAS to synchronize with the folder on your device, saving storage space on your device and increasing synchronization efficiency.

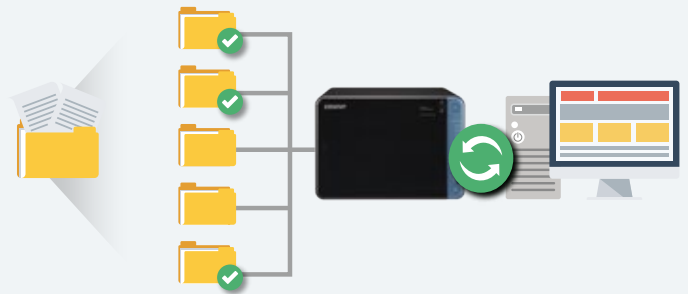

With Qsync, you have all the files on your NAS at your fingertips wherever you go

Preview the files on your NAS from anywhere

Simply connect and select files to access on the NAS. You can easily move, copy, rename, or delete files on the NAS without needing a computer.

✍ Supports Android™ 4.0 (or later) devices.

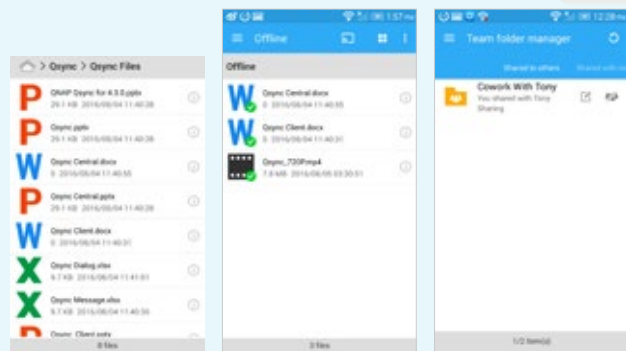
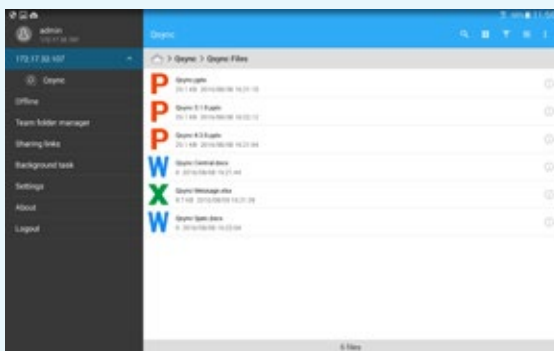

Offline Browsing

For offline browsing, simply download files, photos or files from the NAS to the offline browsing folder. After weighing out the importance of the files and the available space on your device, you can download the most important files for offline access. You can also configure settings such that synchronization is only carried out when the device is being charged and connected to Wi-Fi.

Synchronize mobile data to ensure no important data is lost

Select the folder on your mobile device to be synchronized with the Qsync folder on your NAS. Keep important files on your mobile device, computer and NAS at your fingertips while you are on the go.

Enhance collaboration through instant sharing

Create a download link for files or folders, and send links through email, SMS or messenger apps. In addition, you can also share team folders with other NAS users. Once they accept the invitation, you can work collaboratively on the files in those folders.

Supports multimedia playback

Stream music, photos and videos from the NAS. With the NAS acting as the storage for your mobile device, you no longer need to set aside huge amounts of space on your mobile device for storing audio and video files.



Create your private cloud easily with remote connection services **myQNAPcloud 2.7**

The myQNAPcloud setup wizard will guide you in creating your private cloud. With myQNAPcloud 2.5, you can access QNAP NAS cloud services safely and conveniently at any place and at any time.



myQNAPcloud ID (QID)

Access your QNAP NAS by signing into your myQNAPcloud portal (www.myqnapcloud.com), the mobile app, or Qsync on your computer with "QID", your unique ID for accessing your NAS and sharing your private data and files securely.

Supports SSL secure connection

myQNAPcloud SSL certificates are used for establishing secure channels of communication between the browser and QNAP NAS, as well as for server authentication and encrypted data transmission. These channels ensure the security of all data passing between the QNAP NAS and web browser. After purchasing and installing a myQNAPcloud SSL certificate, when you use DDNS to access the NAS, you can be confident that you are accessing a secure and genuine website.

CloudLink Remote Connection

CloudLink is the best connection method for connecting to your QNAP device via the myQNAPcloud web portal (www.myqnapcloud.com). You do not need complicated router settings. Just register for a myQNAPcloud ID (QID) on your device and enable CloudLink. You can then sign into myQNAPcloud web portal using your myQNAPcloud ID (QID) to connect to your QNAP device. CloudLink will automatically select the best connection method based on your network environment. Other than web-based connections, CloudLink also supports connection via the QNAP phone App or Qsync. With CloudLink remote connection is a breeze.

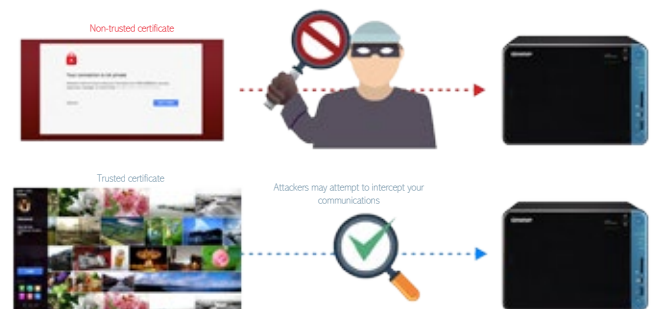

Web-based management of multiple devices and files

The myQNAPcloud website (www.myqnapcloud.com) is a user-friendly interface that allows you to check for available and connected NAS servers. Download, move, copy and share files stored on your QNAP NAS on your web browser, and enjoy the convenience of accessing multiple NAS from a central Internet portal. myQNAPcloud is a fantastic assistant if you own multiple QNAP NAS.

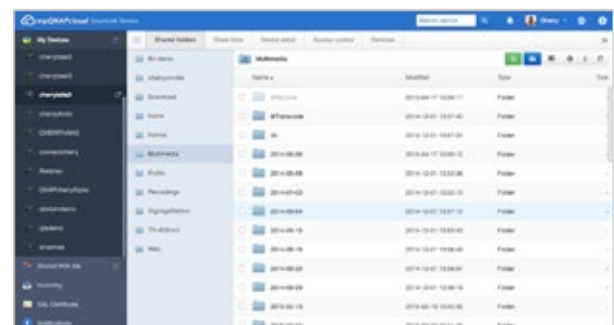
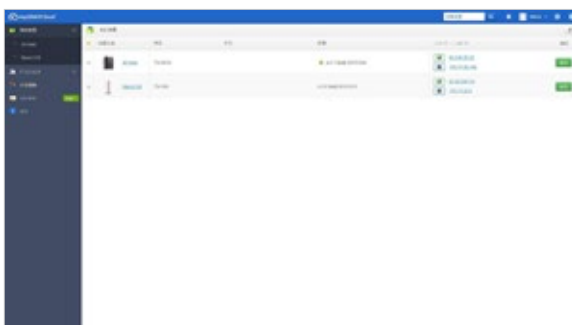

Experience a more perfect design

QTS 4.3 NAS Operating System

Easy to use

System overview

Cloud install - Simple and intuitive NAS installation

After setting up your hardware, follow the instructions on the Quick Setup sticker to initialize your NAS. You can either visit install.qnap.com on your browser and enter the Cloud Key, or scan the QR code on the sticker with a mobile device to begin NAS initialization.

✍ For further information, visit start.qnap.com.

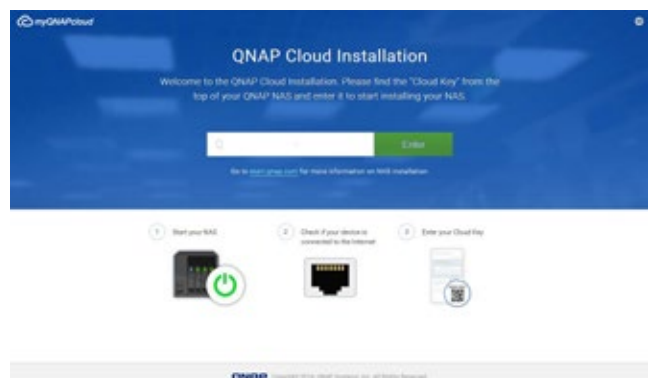

Smart dashboard

System status can be easily viewed with a single click on the icon in the top-right corner of the desktop. Use the smart dashboard for an overview of important system information, including system health, hard disk health, resource management, storage space, scheduled tasks, and real-time information on the device and firmware. Drag and drop dashboard functions to the desktop to monitor them at any time. In the event of a critical failure the smart dashboard will flash and prompt the administrator to take immediate action to prevent data loss.



Push service

In addition to email and SMS, you can get messages sent to mobile devices if a system failure or other events occur*. With the latest system status at your fingertips, you can react immediately to rectify the situation and minimize the risk of data loss.

✍ Only supports Chrome™ 42 (or later) or Safari OS X 10.9 (or later).

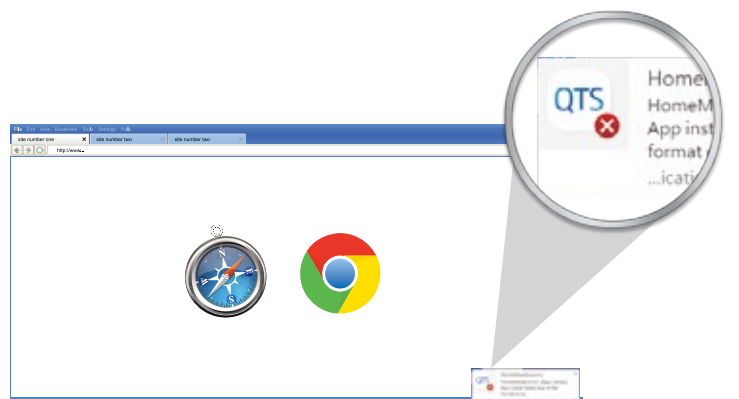

All-round defense for protecting your data

Data Security

Organizations may suffer significant financial losses if important data is leaked or lost due to hardware malfunction or external attacks. With increasing risks of data breaches and leaks, network storage security is gradually taking center stage. Confidential business files, as well as personal photos, videos and multimedia files, are especially in need of greater protection. QNAP helps you to minimize the risk of data breaches with our multiple protection mechanisms, allowing you to focus on data application, rather than data protection.

Network environment protection

Connection management (black/white list)

Allow or deny connection to the NAS from specific IP addresses or subnets by creating whitelists and blacklists for filtering IP addresses. Servers with blocked IP addresses will be unable to connect to the NAS. For example, block an IP address from accessing the NAS for one hour, one day, (or permanently) if there are five failed login attempts within a minute. Servers that use the blocked IP will be unable to connect to the NAS. Block users that have been online for too long or who have logged in from a suspicious IP for enhanced system security.



Service Binding

QNAP NAS with multiple Ethernet ports generally permits data access through every port. However, this can compromise data security. Service binding allows users to bind network interfaces with only specified services for enhanced system security. For example, critical company data can only be accessed by certain personnel through specific protocols or permitted internal IP addresses. Not only is security enhanced through allowing/denying access to specific network services and network cards, service binding with LAN ports also ensures that critical services get dedicated bandwidth.

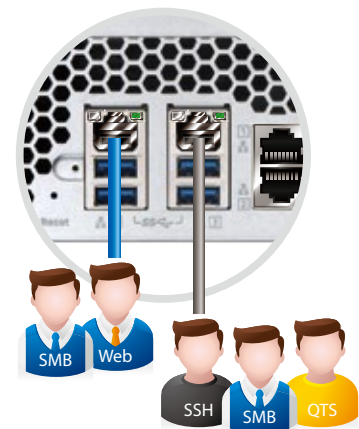

Account security and system notifications

Two-step Verification

Two-step Verification* requires users to sign in to the NAS with their username, password, and a 6-digit one-time password (OTP) generated by an authenticator app. This gives you added security in case your account information is lost.



* To use this feature, you must install one of the following authenticator apps on your mobile device: Google® Authenticator (Android™, iOS®, BlackBerry®) or Authenticator (Windows® Phone).

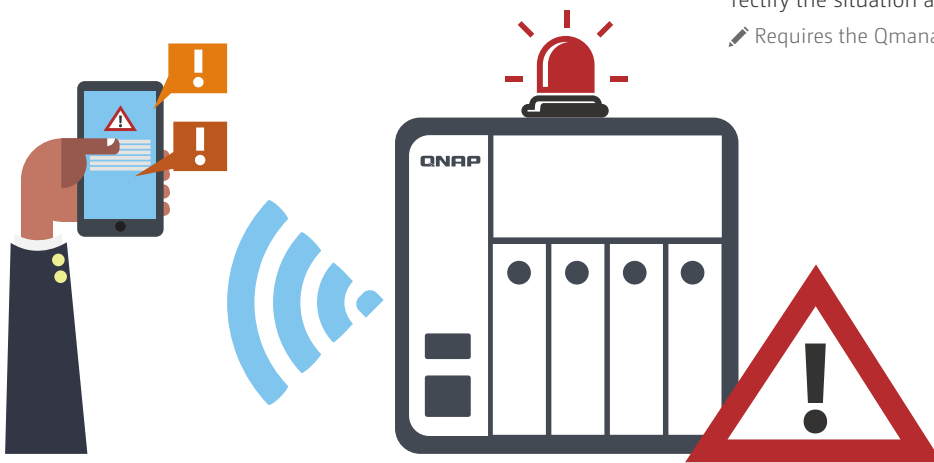

Push service

In addition to email and SMS notifications, messages can also be sent to your mobile devices or web browser in the event of a system failure or other warnings*. This keeps you updated with the latest system status so that you can take immediate action to rectify the situation and reduce the risk of data loss.

Requires the Qmanager mobile app.

Data encryption protection

Encryption for the entire system

QTS offers volume encryption to protect all of the data stored on the NAS. The system will ask for the encryption key when mounting encrypted volumes, and the data will be inaccessible without it. This feature effectively protects data against unauthorized access if the entire NAS or individual drives are stolen.

Folder encryption

Besides encrypting entire volumes, QTS also allows you to encrypt only specific folders and protect their contents from unauthorized access. For security reasons, the contents of shared folders will also be encrypted.

Protection by transmission encryption

Network transmission encryption

Advanced AES encryption ensures the security of shared folders. Without the key, no one can access the data in encrypted folders or files. Data transmitted over the Internet can also be encrypted for security while using FTP, WebDAV or File Station services.

Encryption is provided for the following services:
rsync backup (SSH encryption), RTRR backup (TLS encryption), SFTP: FTP (SSH encryption) FTPS: TLS encryption, web server (TLS encryption), shared access (SSH encryption)

QTS 4.3 not only supports certificates uploaded from control platforms and issued by authorized units, it also allows the creation of self-signed certificates, or certificates obtained from Let's Encrypt (a public certificate authority).

Encryption of External Hard Drives

External storage devices are convenient for data migration as they can be easily attached and detached. QNAP NAS supports encryption to protect against unauthorized access of external drives in event of loss or theft. You can choose to protect your data using AES-128, AES-192, AES-256 or other forms of encryption.

Anti-Virus protection

QTS is integrated with the ClamAV™ antivirus toolkit to protect your system against the latest viruses, malware, worms, and Trojan horses. Continuous free virus database updates ensures that your business is not disrupted. Administrators can select specific folders for immediate or scheduled virus scans. If viruses are detected, email notifications will be sent to the administrator. You can also choose McAfee™ anti-virus software to protect your important data.

McAfee™ anti-virus can be purchased from the App Center.

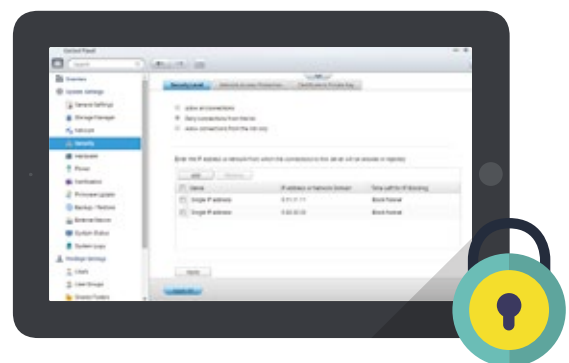

Let's Encrypt is a third-party entity. QNAP is not responsible for its security, compatibility, or reliability of its services. When in doubt, use myQNAPcloud SSL certificates. For more information, refer to the myQNAPcloud section.



Fine tune your NAS performance with the integrated monitoring app

Resource Monitor 1.0

All-new interface

All monitoring elements in the Resource Monitor have been redesigned for better identification, and hyper threading is now displayed as average values. All Ethernet and wireless network usage and other information are available to you at a glance in Resource Manager,. The simple and elegant interface gives administrators an instant overview of NAS resource usage, making monitoring easier than ever.

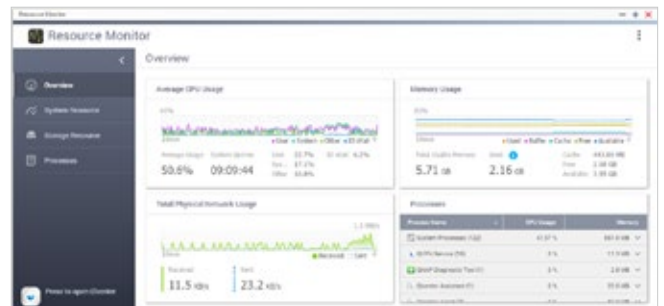

Differentiated analysis of storage efficiency

Through the resource monitoring menu, you can choose to monitor the IOPS, latency rate, throughput and other information on various disks in real-time. Information on RAID groups, volumes and LUNs can also be displayed in charts. Monitor current SSD status in the form of cache activities, and assess how much they are increasing the performances of target volumes and LUNs. Keep tab on the performance of the two RAID groups in the high-speed and high-capacity tiers.



✍ QTS 4.3 will add additional SSDs swap area, which will be used more preferentially than hard drives to enhance processing performance.

List of applications by type

No other monitoring software can match Resource Manager in providing information on your QNAP NAS. Not only can Resource Monitor track the usage of processing and storage resources, it also sorts the applications by their types. This helps administrators effectively identify various applications (Virtualization Station, Qsync, etc.) and monitor their resource usage and consumption rates. The collected data can help troubleshooting, hardware maintenance and update planning.

Process Name	User	PID	Status	CPU Usage	Memory
System Processes (100)	--	--	--	6.96%	844.2 MB
Qsync Service (10)	--	--	--	0%	11.3 MB
QNAP Diagnostic Tool (1)	--	--	--	0%	2.6 MB
Client Assistant (1)	--	--	--	0%	29.0 MB
Client Agent (3)	--	--	--	0%	31.9 MB
Client (4)	--	--	--	0.28%	61.7 MB
mongod	admin	7985	Sleeping	0%	54.8 MB
rsyncd	admin	10272	Sleeping	0%	2.4 MB
tee	admin	10321	Sleeping	0%	1.1 MB
rsync	admin	11115	Sleeping	0.25%	2.4 MB
Proxy Server (14)	--	--	--	0.12%	504.4 MB
rsync	admin	4114	Sleeping	0%	8.2 MB
clamd	admin	3875	Sleeping	0%	443.6 MB
rsync	admin	3935	Sleeping	0%	1.5 MB

Allocate user accounts and access privileges flexibly

Home Folder

Enable the Home Folder feature to automatically create personal folders for authenticated users. The home folder is created the first time users log into the NAS. With this feature, IT administrators no longer have to create folders and set privileges separately for each NAS and domain user. All home folders will be listed in the "homes" folder in File Station, making it easy for IT administrators to perform backups.

Reduce administrative burdens with centralized authentication

The Lightweight Directory Access Protocol (LDAP) and Windows Active Directory (AD) are enterprise-level tools enabling IT administrators to connect to, search, and centrally manage network resources. QNAP NAS supports both services. Administrators are able to centrally create and manage user/groups in lieu of maintaining separate user account information on each NAS. Domain users can use credentials from either service to access network resources (including the NAS) without remembering multiple account credentials. This greatly reduces the burden on IT administrators and increases overall user productivity. In addition to joining your NAS to an Active Directory Domain, your NAS is able to act as an LDAP server. Other QNAP NAS and LDAP clients (e.g. Mac and Linux PCs) bind to the server joining the directory service, enabling management of LDAP user/group access privileges to NAS, while eliminating the need to acquire and maintain a dedicated LDAP server.

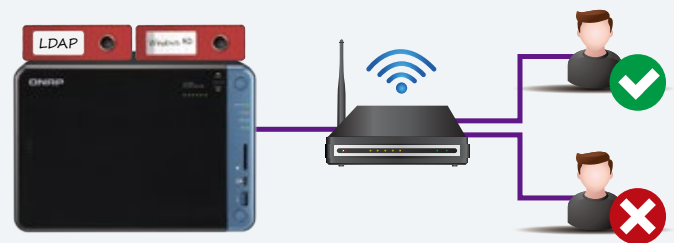
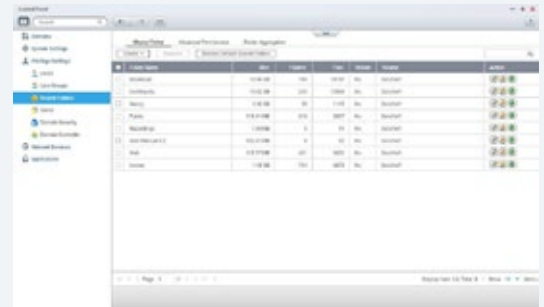

Windows ACL

Windows ACL enables IT administrators to configure file and folder permissions for local and domain users on a NAS. Enable this feature and configure basic and 13 advanced permissions from Windows File Explorer. These permissions grant or deny access to files and folders and will be aligned with the shared folder permissions on the NAS. Additionally, apply permission settings to Samba, FTP, AFP file sharing, and File Station by enabling "Advanced Folder Permissions".



Qmanager - Remote surveillance and management

With Qmanager, you can review system and connection records, restart or shutdown your QNAP NAS remotely and wake up your NAS with WOL using a mobile device. Safely unmount external devices with Qmanager to ensure all ground is covered in your monitoring system.

✍ Supports: iOS®, Android™ and Windows® mobile devices.

Manage users and shared folder privileges

Management is a breeze with a simple and elegant interface. Easily use mobile devices to monitor users, user groups and shared folder statuses.

Manage backup tasks

Check the status of current backup tasks using mobile devices or initiate saved backup tasks.

Push notifications

Check system events, real-time updates, and receive important push notifications on mobile devices.

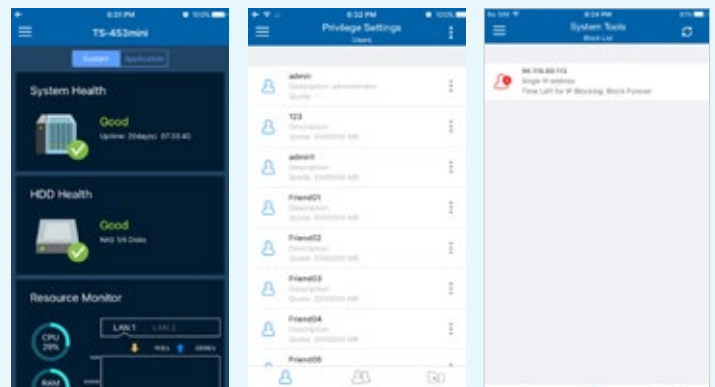

Provide IT managers with the greatest ease of deployment

Network management and setup



All network settings at a glance

Network & Virtual Switch 1.4

The new Network & Virtual Switch integrates existing QTS network management functions, such as TCP/IP, IPv6, Wi-Fi, USB QuickAccess and Wireless AP. A new overview page and virtual switch functionality has also been added. Now both individuals and businesses can enjoy optimized network building and management through these two functions.

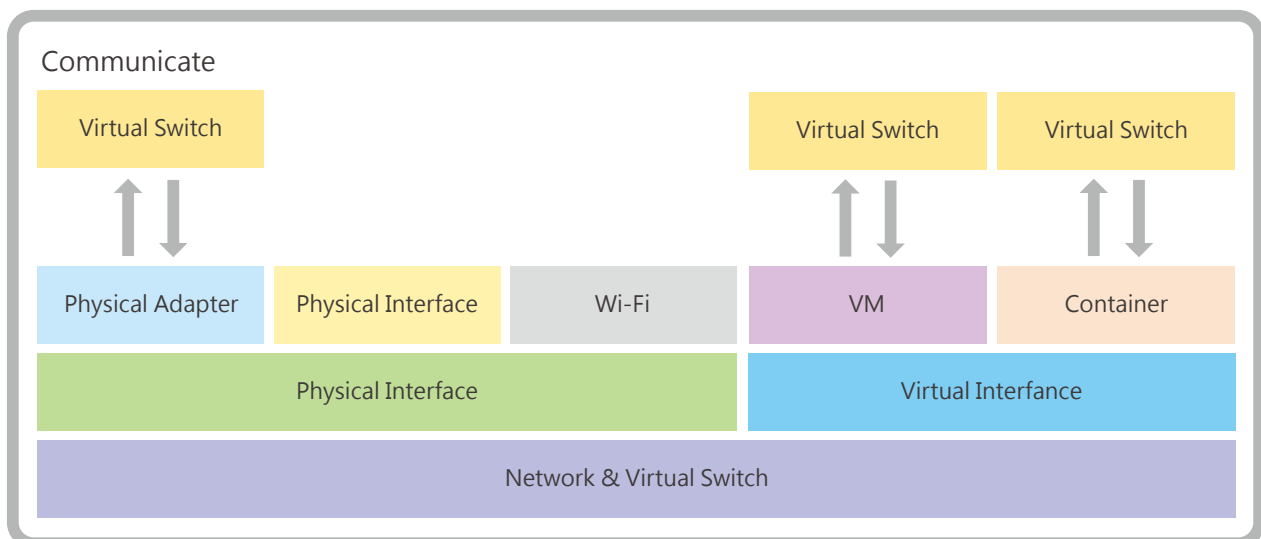

New Overview Page, network statuses at your fingertips

With the new Network & Virtual Switch overview page, both IT administrators and general users can get real-time information on network connection statuses. The powerful overview visualization provides you with the latest connection status regardless of the complexity of your network infrastructure. In event of a disconnection, you are able to troubleshoot quickly, and reduce time costs.

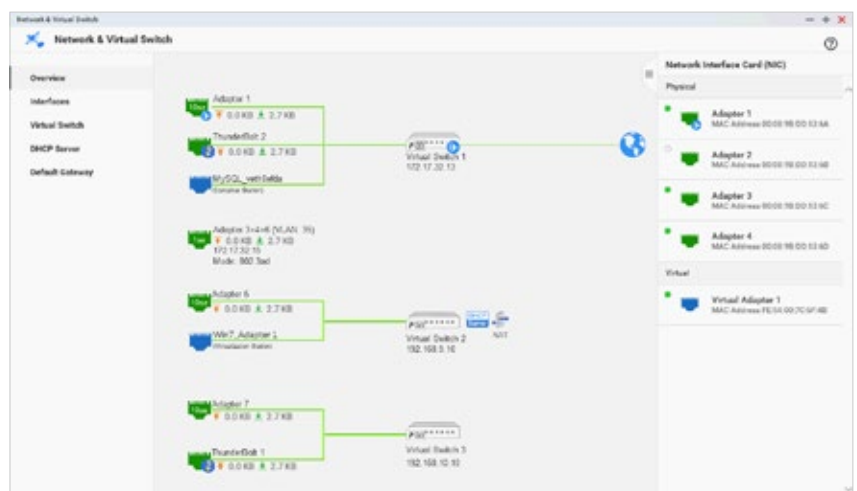

Use Port Trunking to increase overall service bandwidth

Through Port Trunking (port aggregation; also known as LACP: Link Aggregation Control Protocol), you can combine two or more network interfaces, and thereby balance the loads and increase network bandwidth to maintain transfer speeds in multi-user scenarios. In addition, the network fault tolerance feature allows mutual support between multiple Ethernet interface adapters, such that if one adapter malfunctions, another adapter can maintain its connections and ensure uninterrupted services.

- ✍ QNAP provides seven different Port Trunking agreements (to be used with supported network switches).
- ✍ The overall transmission performance is dependent on the read/write speeds and configurations of storage devices (such as SSD or HDD; type of RAID).

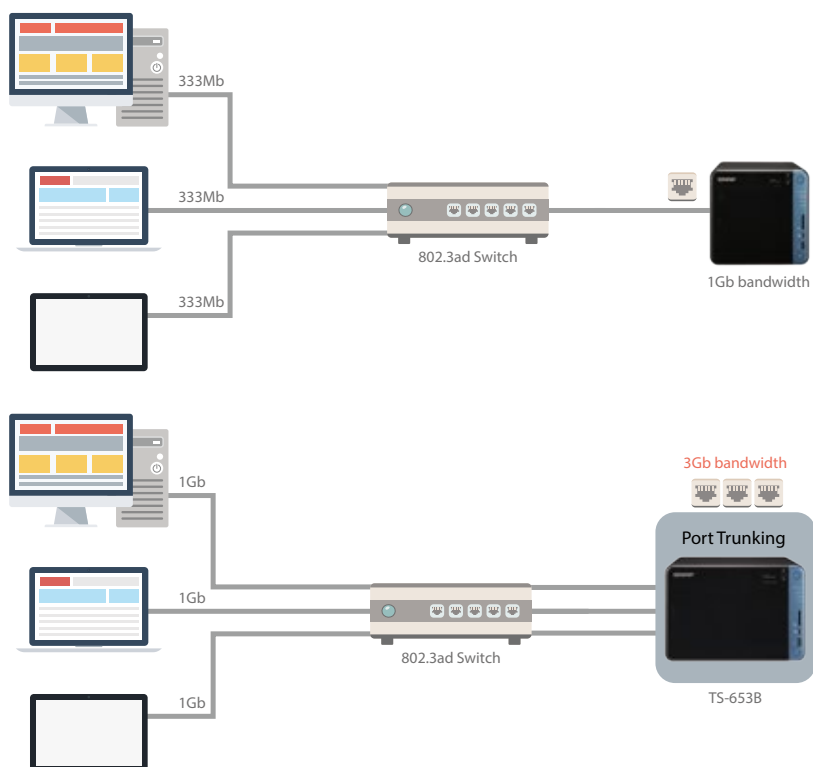

USB QuickAccess

The USB 3.0 QuickAccess port coupled with Qfinder Pro allows you to complete the first-time installation and setup without requiring network connectivity. By connecting the USB QuickAccess port on the front panel to a Windows or Mac computer, shared folders on the NAS can be directly accessed using Qfinder Pro. Everyone can then access their data without needing network connectivity. Furthermore, you can assign access privileges to users for different folders to prevent unauthorized access to important files.

- ✍ USB cable sold separately.



Decouple hardware and software networking for lower capex, opex, and increased ROI.

By using virtual switches, the NAS can easily bridge Gigabit and 10 Gigabit networks, without expensive 1/10Gbps Ethernet switches. You can also bridge 10GbE networks for file access and exchange. Simply connect the 10GbE network devices to enjoy the large bandwidth. On top of that, you can also use a virtual switch to build an isolated LAN environment with the built-in DHCP server for accessing IP camera surveillance footage in a closed network environment. Data security is enhanced as the recordings can only be accessed through the Intranet.

- » All physical and virtual ports can be interconnected. (So that virtual machines can also make use of high-speed network ports)
- » Communication between different virtual machines can also be carried out through the Virtual Switch. (E.g.: the server VM will be able to access the SQL Database service hosted on a container)

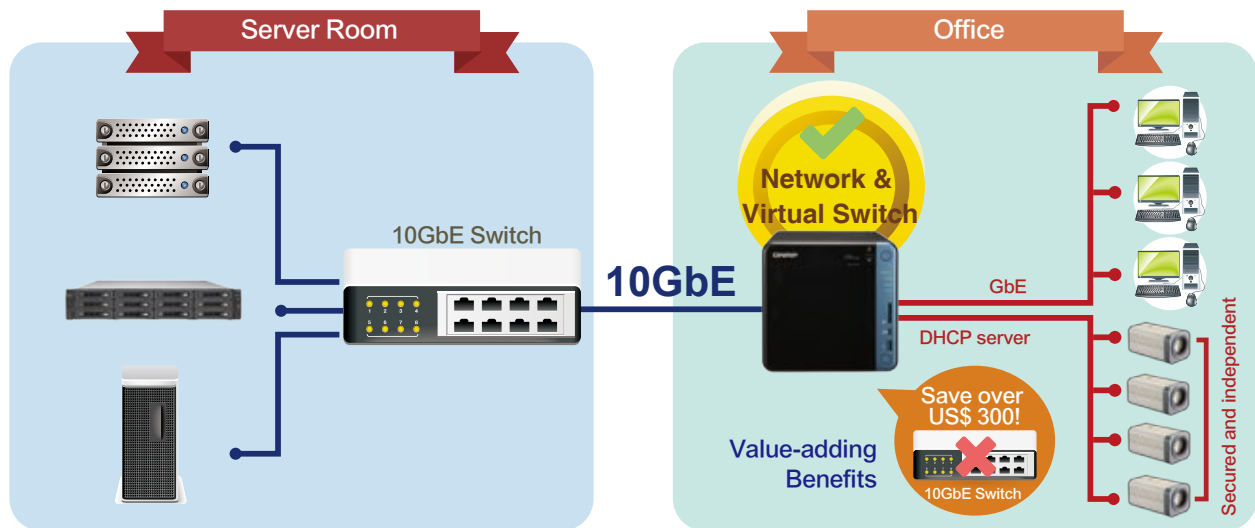

Using Thunderbolt and Virtual Switch together

When you connect your computer to the NAS through its Thunderbolt 2 port, not only can you access your data at high speeds, you can also use the T2E virtual switch to facilitate communication between your device and virtual machines.

- ✍ Transmission speed is dependent on your NAS system resources.

T2E (Thunderbolt To Ethernet) Converter

You can create a two-way network transmission environment by simply configuring the network settings of the T2E converter and binding the interface card. With its Thunderbolt Converter, the QNAP NAS can help bridge physical and virtual interface cards.

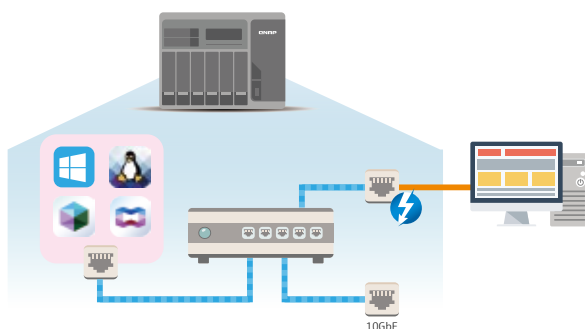

Thunderbolt Residential Gateway (NAT)

By enabling the NAT service of the Thunderbolt Virtual Switch, Thunderbolt devices can be connected to all network ports and virtual machines through the NAS, without configuring complicated network settings.

- ✍ Thunderbolt devices under the NAT architecture do not support end-to-end host connections and some Internet protocols.

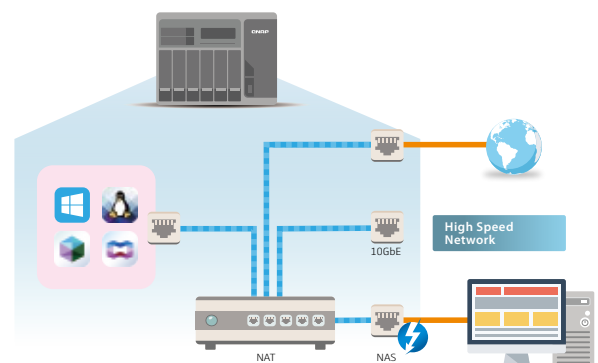



Use a QNAP NAS as a wireless base station

WirelessAP Station

With QNAP wireless base station service, QNAP NAS can be transformed into the most convenient wireless base station. Install a compatible PCIe wireless network card and download the WirelessAP Station app to allow devices to connect to your NAS for directly accessing its services and Internet connection.

✍ For detailed installation instructions, see "How to Get It"

Supports network card	Supported channels	Highest bandwidth	Number of antennas
TP-LINK TL-WDN4800 N900	2.4G / 5G	2.4Ghz : 450Mbps 5Ghz : 450Mbps	3
TP-LINK TL-WDN3800 N600	2.4G / 5G	2.4Ghz : 300 Mbps 5Ghz : 300 Mbps	2
TP-LINK TL-WN881ND N300	2.4G	2.4Ghz : 300 Mbps	2
TP-LINK TL-WN781ND N150	2.4G	2.4Ghz : 150 Mbps	1

* TP-Link wireless network cards are sold without flat brackets for the QNAP TS-x53B. Brackets are not required and can be removed from these wireless network cards when installing to the TS-x53B.

Five major benefits

- 1 NAS - x86 level of wireless network access point
- 2 Directly connect to the NAS with a wireless network
- 3 Scalable Entity AP - add several access points with multiple expansion cards
- 4 Set up separate wireless connection interfaces (such as: IoT / VM / Container) as needed
- 5 Enjoy network optimization with traffic shunting

Scalable physical wireless access point

Traditional wireless network routers use software-based (virtual) access points to share "single and identical" physical devices, but this will be limited by the bandwidth of a single network card, making it difficult to stabilize connections. When you need to use the wireless network at the same time, the wireless base station service allows you to increase the bandwidth that is actually available by adding physical network cards without interfering with each other. For example, you can install two wireless network cards in QNAP NAS and configure them respectively as 2.4G and 5G base stations, then the NAS will be able to simultaneously provide services at different frequency ranges.

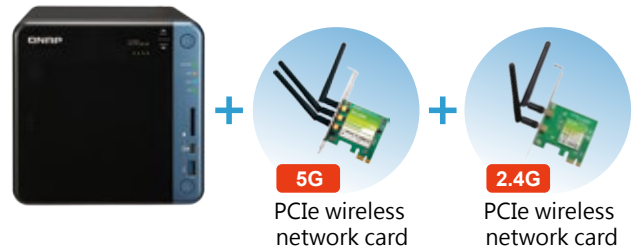

Solution comparison

	QNAP Wireless Base Station Service	Home AP/Router	Professional AP Router
CPU	With dual-core x86 CPU and above processing power	MIPS 24K, 74K 380 ~ 600MHz	Dual Core ARM, MIPS 800M - 1GHz
RAM	Over 1GB	32 / 64MB	128 / 256MB
Flash	With more than 512MB of storage space, and direct NAS integration	8 / 16MB	128MB

Directly connect to the NAS

Enjoy the wireless network services provided by QNAP NAS on mobile devices and use rich applications such as Qfile, Qmusic and Qvideo.



Enjoy network optimization with traffic shunting

The high performance of QNAP NAS not only provides you excellent data access services, but also allows you to enjoy smooth NAS connectivity. In general, even if you are at home using a mobile device to connect to the NAS, you still need to use the wireless base station function of a router to connect to the NAS. Therefore, when the router is busy, the quality of the NAS connection will be affected. The base station set up by the wireless base station service allows your device to connect directly to the NAS, so that you are no longer limited by the performance of the router, and can enjoy excellent network shunting and connection speeds.

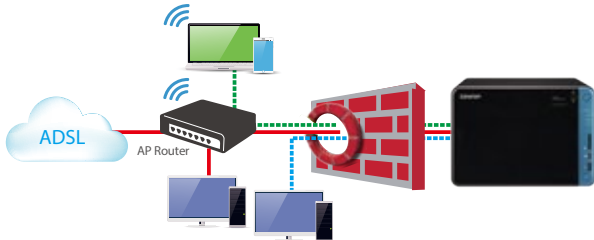

Network connections using traditional architectures

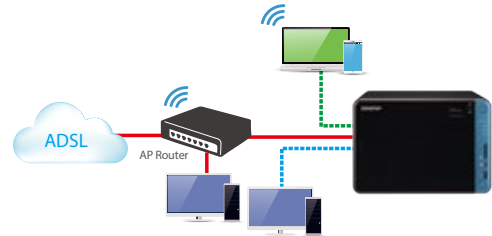

Network connections when using the QNAP wireless base station service

Freely set up an independent, secure wireless connection interface

In addition to shared resources, you can also assign individual NICs to the Container or use different QNAP services as required through integration with QNAP Network & Virtual Switch, and enjoy a separate wireless connection interface. You can also create a small private network, for example: When you need to set up a highly private Internet of Things environment, you can set it up to not pass through any other sharing devices, so that your IoT network becomes a highly secure and reliable independent network.

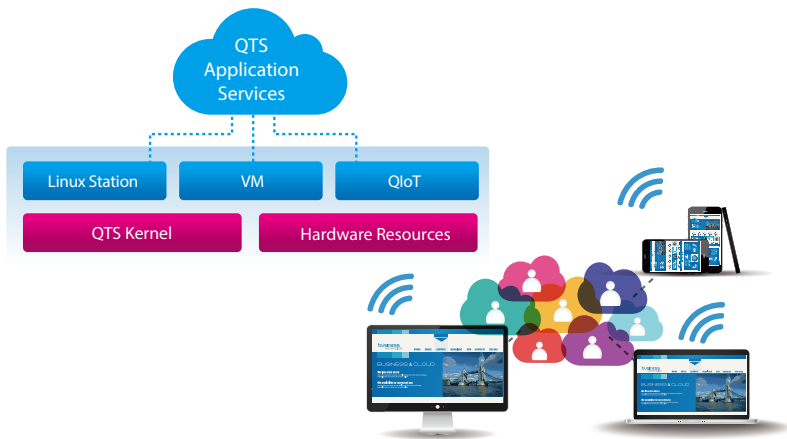

System architecture

The Wireless base station service is based on OpenWrt in conjunction with the QTS LXC Container technology.

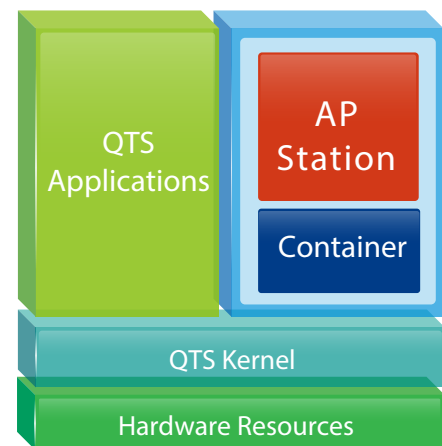

How to get it

You can download wireless base station services from the QNAP App Center. A setup wizard is provided to make installation and set up as easy as possible. Install the wireless network card, download WirelessAP Station, then follow the instructions to quickly complete the setup process.

- 1 Install the wireless network card



- 2 Go to the App center to download and install Container Station, then download the wireless base station service (WirelessAP Station)



- 3 Once set up, your devices will be able to wirelessly connect to the NAS.





Affordable virtual private network **QVPN Service**

A Virtual Private Network (VPN) allows secured access to network resources and services across public networks. It provides secure and encrypted connection for data transmission. Both home and business users can create affordable and secure virtual private network environments by selecting the QVPN services on the NAS (L2TP/IPsec, PPTP or OpenVPN) or on the client (L2TP/IPsec, PPTP or OpenVPN).

QVPN server service

With a VPN server on your NAS, you or your employees can connect securely to servers or other shared resources on your home or corporate private network even if you're away from home. QVPN server in QVPN Service also provides account and connection management, and support remote user connection in addition to local users, so you can effectively control VPN service access. Furthermore, a VPN can help you access resources that may otherwise be restricted by your network environment.

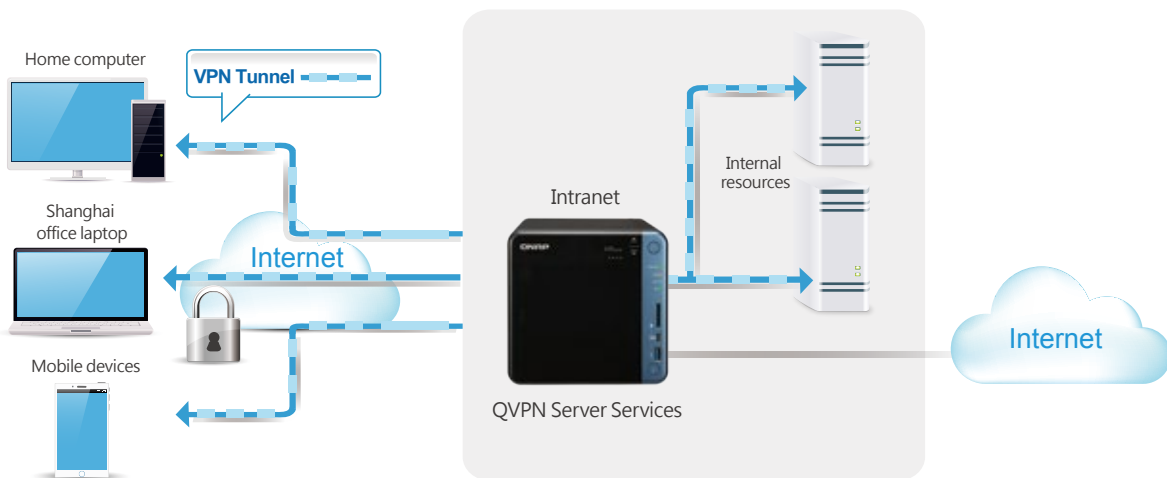

QVPN Client Services

You can also use your NAS as a QVPN client to be connected to the QVPN server on another NAS or other VPN servers. When using a download service (such as BT, eMule, Thunder), QVPN connections can protect your privacy. You can also create a safe network channel for remote support (e.g.: you can configure the NAS to be a VPN client for secure data transmission when setting up backup or other services to branch offices at overseas locations).

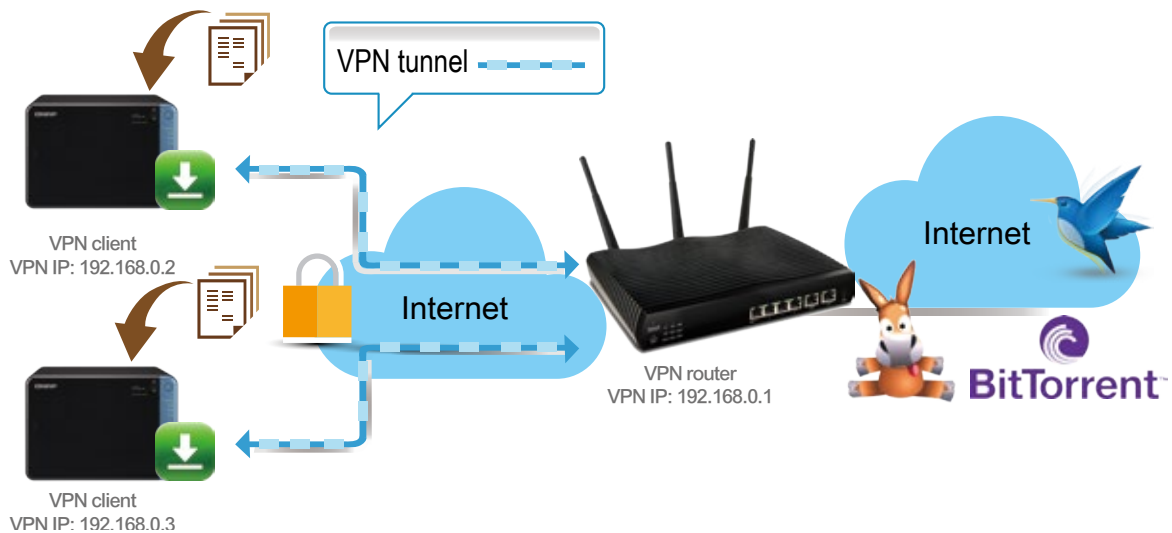

Introducing VyprVPN

QNAP is proud to be the first NAS manufacturer to support Golden Frog (a third-party VPN service provider). Compared to other VPN Apps, VyprVPN offers advanced network management solutions that provide users with high-speed and highly secured VPN network. Through VyprVPN, a QNAP NAS user can connect to Golden Frog servers around the world through either PPTP or OpenVPN.



✍ QNAP users can enjoy a VyprVPN trial service. Relevant fees will apply when using this service after the trial period ends.

Support for multi-connection VPN clients

A single VPN Client now supports multiple VPN connections to different QVPN servers. For example, a NAS can simultaneously tunnel to VPN servers on both a business and a client site. This allows backups using Backup Station, as well as remote connections using Samba in File Station for secured data transmissions.

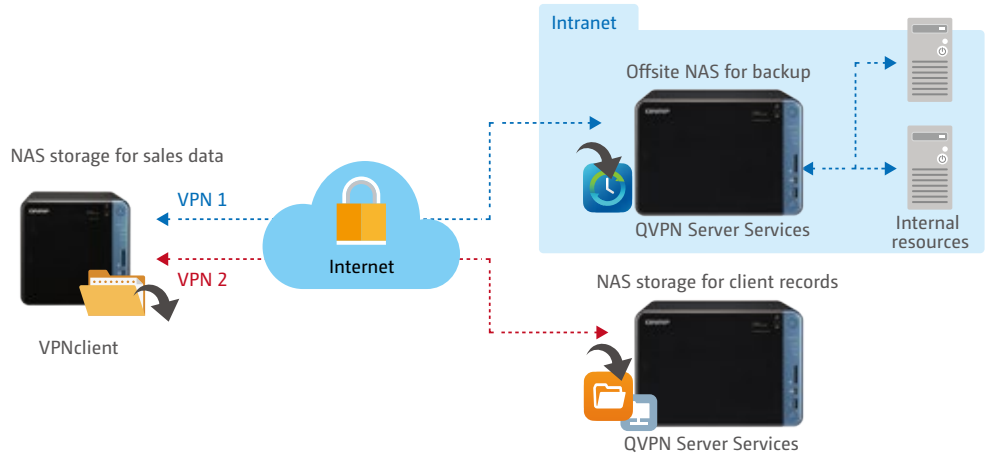

Simultaneous VPN server and VPN client roles

A NAS can simultaneously serve as a VPN server and VPN client. This way, VPN servers that are part of the NAS can be connected to different network interfaces according to NAS settings to access devices on the network and connect to the Internet. For example, you can configure the NAS to be a VPN server to allow secured access to Intranet resources from remote devices; you can also set up the NAS to connect with other VPN servers for services such as Netflix and Hulu via HD Station, bypassing regional restrictions on these services.

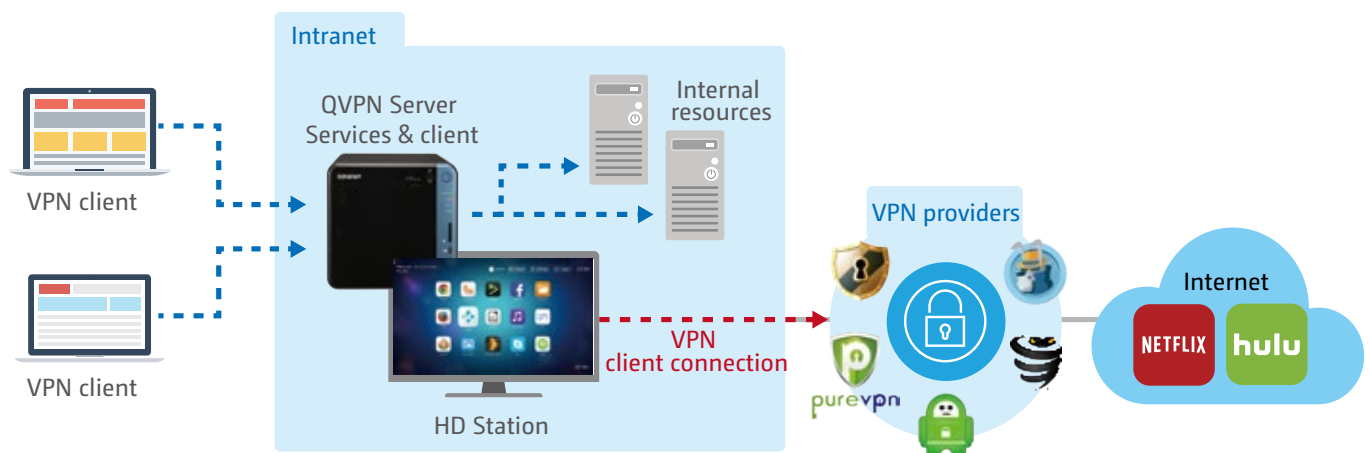

✍ VPN Server, VPN Client, and L2TP/IPsec VPN services have been integrated into QVPN Service. To use VPN-related features, install QVPN Service from the App Center. Existing VPN-related settings will be automatically retained.



Network Proxy Server Proxy Server

The Proxy Server provides an intuitive interface to simplify proxy server settings on your NAS. You can operate your own proxy server in just a few clicks. The Proxy Server provides cache and connection controls for Internet services. For companies that need a boost to web response time and security, this application can turn your NAS into a web proxy server to protect other devices in your local network from Internet attacks.

Highlighted Features

- » Caching: Improves response times and saves bandwidth required for web access by caching visited web content and other web resources. You can access cached content without consuming any bandwidth.
- » Content Control: lets you restrict or limit connectivity to web sites, servers, or computers.
- » Maintain logs: Record user behaviors in log files, which can be used to analyze user habits and interests.
- » Antivirus: QNAP is integrated with SquidClamav, an antivirus suite for proxy servers, which scans each package received through the proxy server. QTS also supports file and account whitelist settings that allow you to select trusted content (only supported by x86-based models).
- » Advanced Settings: Users can enter Squid commands to customize the proxy server, edit cache settings, and access control without an SSH tool.
- » Smart Blacklist: After updating to Proxy Server 1.3.0, you can enable Smart Blacklist, which uses SquidGuard technology. Once you have enabled the blacklist function in the Proxy Server and downloaded the pre-defined blocking list, you will be able to block all of the classified sites at once. The blocking list can be updated at any time, so you no longer need to manually block any single site. The smart blacklist also provides a query function that can quickly confirm whether a particular site is blocked among tens of thousands of sites.

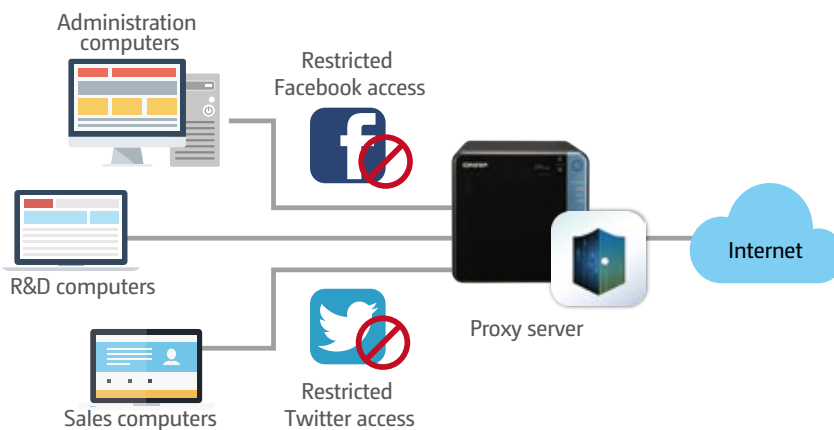

Ideal for Proxy Server deployments

The Proxy Server uses storage space on the device as temporary cache to conserve external connection bandwidth and enhance network efficiency. This is an ideal role for a NAS due to the high storage potential and the ability to allocate resources to dedicated cache functions. Caching proxies can also benefit from RAID configurations and/or high performance storage (e.g. SSD) configuration to provide significant performance improvements

Application scenario: Proxy Caching - bandwidth savings and application acceleration

In a university library, a client computer often requests download of large journals and research papers. This uses a lot of bandwidth and is extremely time consuming. Applying the Proxy Server on a QNAP NAS in this library's network environment can help create a high-performance cache space. Frequently-accessed papers can be stored on the NAS and can be retrieved directly from the internal network when needed. Not only does this save time, it also lowers the library's bandwidth cost.

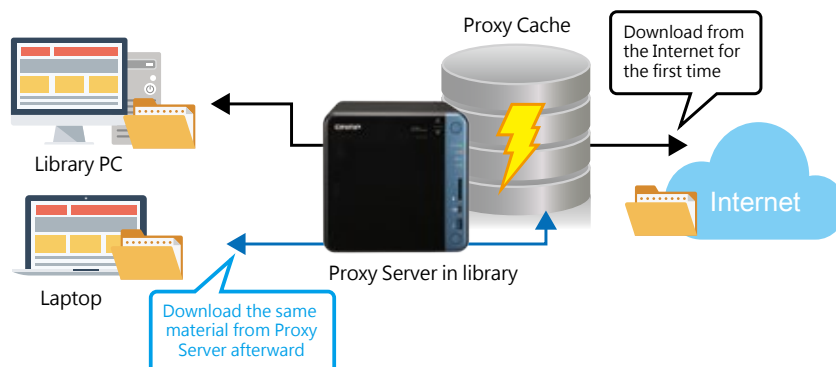

Comprehensive Virtualization Platform Virtualization Applications & QvPC



An all-new experience with further backup advancements

Virtualization Station 3.0

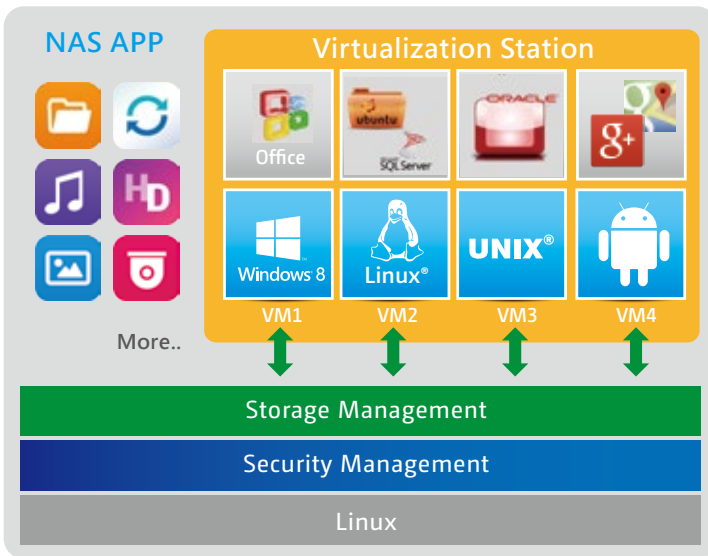

Virtualization Station 3.0 comes with an intuitive and simple-to-operate interface, which can significantly reduce operating time. Incremental Backup is also introduced to reduce transmission time and bandwidth usage during backup. Virtualization Station eliminates the constraints of conventional VMs to provide a better user experience. Create multiple VMs on a QNAP NAS and install Windows®, Linux®, Android™, and UNIX® based VMs so that every VM can serve a different purpose. One QNAP NAS can literally be every type of computer you need.

Software-defined Networking

By adopting a Software-defined Networking (SDN) approach, VMs can now share the network interface with the QNAP NAS to maintain the best data transmission speed without being limited by hardware resources. The SDN architecture comprises the application layer, controller layer and structure layer. Virtualization Station (the Application Layer) can be used for running and managing VMs; the VM Orchestrator is used for receiving signals from the Virtualization Station for task scheduling. When the Virtualization Station orchestrator receives a transmission request from the Hypervisor, the orchestrator will signal the vSwitch Controller (the QNAP NAS network controller), and then the vSwitch Controller will dynamically adjust the Hi-speed Virtual Switch so that VMs can connect with the Physical Networks or NAS storage for data communication. By employing a high-performance virtual switch, VMs are no longer limited by the transmission speeds of the physical NICs when transmitting data between VMs or between VMs and the NAS.

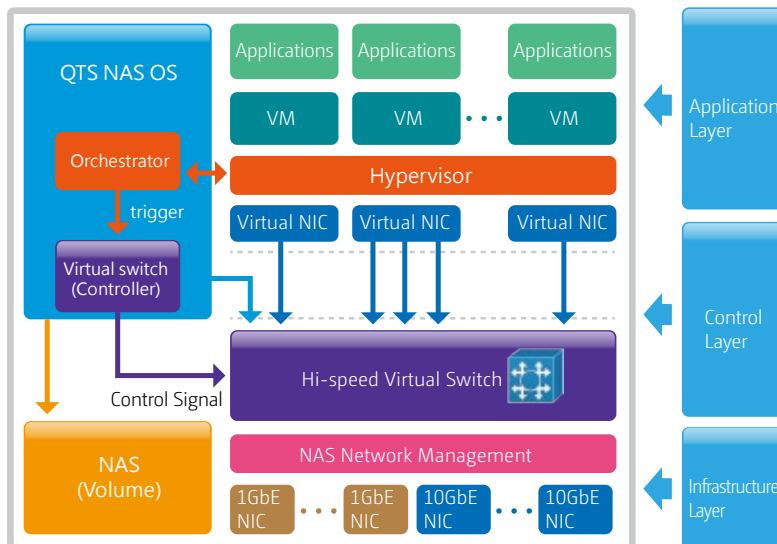

Virtual Switch

Virtual Switches allow VMs to share network interfaces with the NAS, eliminating the need for a dedicated VM network. Bypassing the need to transfer data through physical networks also boosts transfer rates between VMs and the NAS. The Virtual Switch also supports 10GbE and port-trunking, providing fast and secure connectivity.

Bridged Networking

Attaching an Ethernet interface (Port-trunking available*) to a Virtual Switch creates a bridged network. The NAS and the Virtual Switch can share the same Ethernet interface without occupation, and supports high-speed data transfer via internal routing.

✎ Only supports the following Port-trunking modes: Active Backup, IEEE 802.3ad, Balance-tlb.

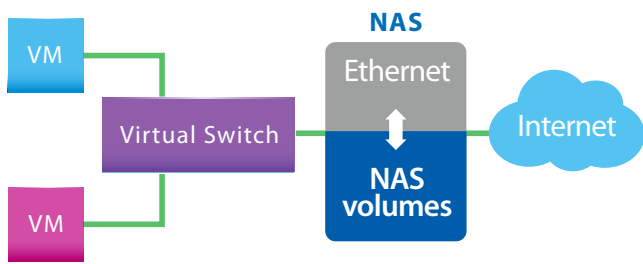

External-only Networking

Specify an Ethernet interface for a Virtual Switch to enable dedicated routing between virtual switches and external networks. Enable DHCP to automatically assign an IP address to a Virtual Switch or choose to manually assign an IP address.

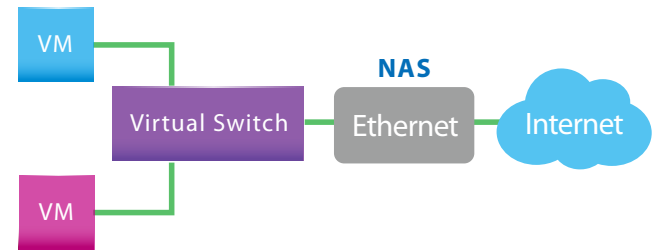

Isolated Network

A network is isolated if the Virtual Switch is unable to connect to any Network Interface. VMs connected to the switch could communicate with each other by manually configuring the VM's IP addresses, but they will be unable to communicate with the NAS or external networks.

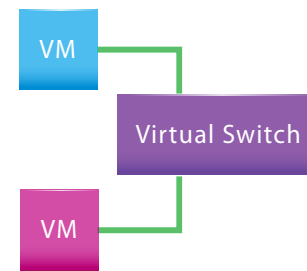

Support QVM 4K, audio output

Through QVM in HybridDesk Station, a VM can be used as PC by attaching a keyboard, mouse, and HDMI display to the NAS. Unlike using an HTML5 web browser to connect to the virtual desktop (which only supports 1080p output with no audio), QVM provides 4K output with analog audio, and can be used for other multi-purpose applications, such as video services.

✎ Web browser (HTML5) uses noVNC to open the virtual machine desktop. This transfer protocol does not include audio transmission. If you require audio output, use Windows® Remote Desktop Connection and SPICE Client. For more information regarding using the SPICE Client, please refer to the "Tutorials and FAQs" section on www.qnap.com



Easily set up VM Backup and Restore tasks

The virtual machine is task-oriented and supports local and remote backup and restore. You can see task progress and schedule in real time through a unified management interface, and you can also start or interrupt tasks. In order for virtual machines to run without service interruption, virtual workstation also supports online backup. You can also set up schedules and upper limits for backups in order to effectively use storage space. It also supports backup directly through the virtual machine while creating local restore tasks, thus reducing downtime during a restore.



Support for Remote Import and Export

Through virtual machine import and export, your virtual machine can be quickly provisioned in QNAP NAS virtual workstation, or other virtualization platforms (Hypervisors).



Support for USB Pass-through

With QNAP virtual workstations, you can use USB devices directly in a virtual machine. General USB storage devices, card readers, keys, and sensors commonly used in factories as well as bar code scanners can be inserted into a USB port on the QNAP NAS and selected directly through the virtual machine information page and be connected to the virtual machine. Through the QVM virtual desktop, its use not only saves bandwidth, but also feels as easy and convenient as actually running in a PC. USB 3.0 is also supported to support high-speed devices.

✍ Currently only supports Windows® 10, Windows® 8, CentOS 7, Fedora 16, RHEL 7, Ubuntu® 14.04, General Linux® 3.4.6 (or later) operating systems.

Exclusive virtualization technology

When you need to download files from a QNAP NAS to a local computer, if the file is too large, it will take a long time and significant bandwidth. Through virtual machines installed on QNAP NAS and their applications, you can open the files directly on the virtual machine, without wasting any time and bandwidth. In the past, certain file formats on a QNAP NAS could not be directly opened, and had to be downloaded to a local computer to open it. If your computer has not installed (or can not install) the corresponding application, you are often unable to open files on the QNAP NAS. However, by using applications in a virtual machine, you can directly view files using virtual machine in different browsers.



Saving bandwidth and time

When you need to download files from the NAS to a local computer, if the file is too large, downloading the file will take a long time and also take up bandwidth. Through virtual machines installed on QNAP NAS and their applications, you can open the files directly on the virtual machine, saving both time and bandwidth.

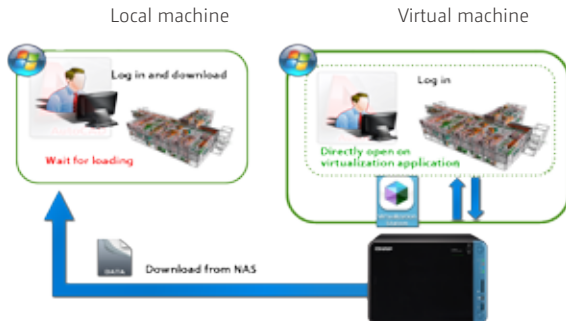

Enhanced security

Through the virtual machine on QNAP NAS and its installed applications, you can directly open and execute files on a virtual machine, so that all information during the operation are kept inside the QNAP NAS, avoiding data transmission and the potential of malicious interception.



User-based permissions settings

Virtualization Station administrators can create users for virtual machines, and set user different permissions. Because each user's needs and purposes vary, from an administrator's perspective, setting up user permissions can enable the administrator to more effectively manage virtual machine usage and resource allocation. From the user's perspective, being able to use the virtual machine independently means that they don't need to worry about incidental actions of other users (for example: power off the virtual machine) resulting in data loss or risk of possible application service interruptions.

- Configurable user permissions include: Remote Desktop permissions: control permissions and view permissions
Virtual Machine control options: Snapshots and Advanced Settings



Operate VMs as Remote Desktops

You can install operating system on a virtual machine, and operate and manage the virtual machine through a web browser. You can also stop the virtual machine, force the virtual machine to shutdown, reboot, shutdown, backup a system snapshot, use Ctrl + Alt + Del on the virtual machine, and open a keyboard and perform other operations.

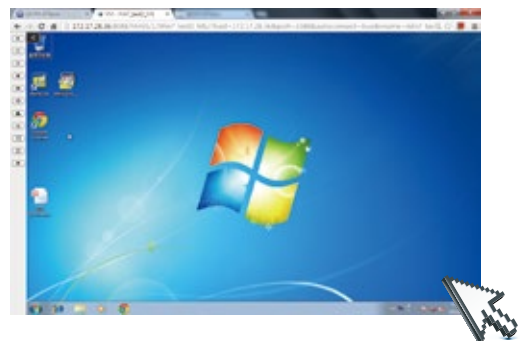

Special column

Windows® virtual machine one-click download fast deployment

Microsoft® allows users to download a Windows 10 virtual machine. After downloading, you can set it up using QNAP Virtualization Station. You can automatically import the virtual machine and quickly create a Windows 10 virtual machine.

- Microsoft® provides this virtual machine is for testing purposes only and it will expire after 90 days. It is recommended that you create a snapshot when you first install the virtual machine.

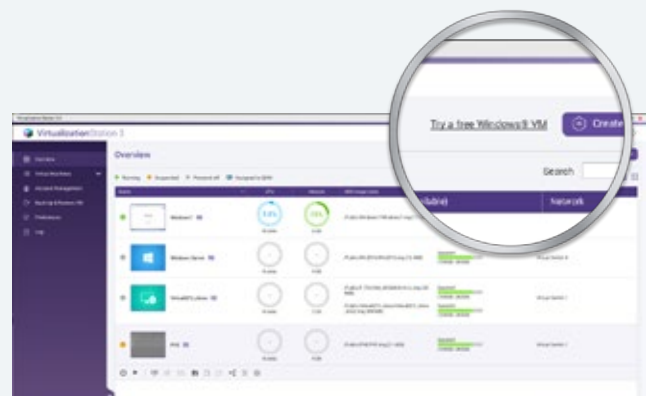



Rapid Deployment of Container-based Applications

Container Station 1.6

With the development of Internet applications and cloud platforms, virtualization has become the only way for an enterprise to enter into the cloud environment. For this reason, QNAP has launched a software container workstation, further streamlining the operating system. With this lightweight virtualization technology, developers and IT managers can easily and freely switch among PC, QNAP NAS and the Cloud. You can use your PC as a development environment, and after completing each stage, containerize the completed software and operating environment, then upload it to the DockerHub™ or export and save to NAS; at the same time, other project members such as testers, project managers, customers or other developers can download and test the software, or continue to the next stage of development. Through interconnection of Container Stations, whether it is QNAP NAS, PC, virtual host or cloud computing, all could become a part of software development.



A growing number of popular apps

Container Station currently provides the most popular and pre-configured applications, and you can rapidly deploy them. The following applications are currently available: LibreOffice, MongoDB, Nginx, Nodejs, Redis, MySQL, WordPress, Deluge, Minecraft, Wine, Jenkins, GitLab, Redmine, Joomla!, OpenERP and more.

Two virtualization technologies to bring even more value to your NAS

- » LXC- lightweight Linux® virtual machine: complete Linux® virtual machine execution using LXC within NAS: can install Ubuntu®, Debian, Fedora and other Linux® virtual containers, with complete operating system functionality.
- » Docker®- rapid deployment of a large number of applications: Implementing Docker lightweight Microservices on NAS.

Install-on-demand applications

Search for official or third-party software directly through Docker Hub Registry. Whether it is a database, web server, programming language or development tool, you can click and install, just like downloading an app on a mobile device.

One-click installation

The Container Station Installation Wizard eliminates complicated setup process, can automatically detect system configuration and easily helps you complete installation. Just click "Setup" to immediately start enjoying rich Container applications.

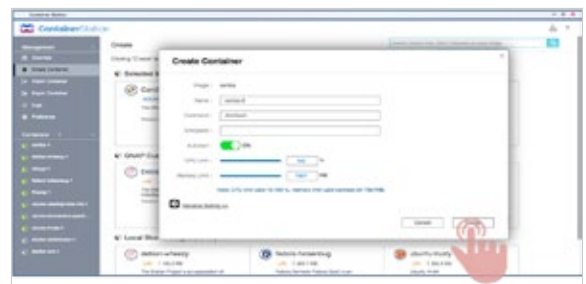

✍ Docker and the Docker logo are registered trademarks of Docker Inc. in the US and other countries / regions. Docker, Inc. and other parties may also have trademark rights in other terms used herein. Linux® is a registered trademark of Linus Torvalds in the United States and other countries and regions.

Access shared folders

Mount folders directly inside software containers or mount folders from other containers. Data generated by the app can be saved at a speed nearly as fast as the host machine.

Export/import software containers

Easily export software containers along with data contained in it to any shared folder. The import/export function not only provides container backup, it also makes container transfer between different QNAP NAS more convenient.

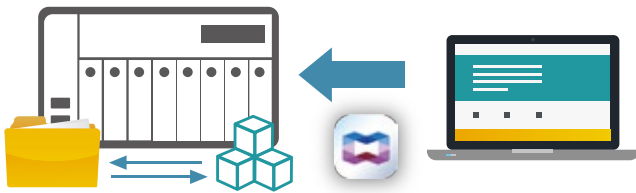

Resource management

Through Data Visualization, you can view host resources at a glance through a browser, and monitor resource usage of each container at the same time, therefore you never get confused whatever the number of installed containers. In addition, you can also set an upper limit of CPU and memory use for individual containers to adjust your NAS for best performance.



A variety of built-in productivity tools to support richer formats

- » Powerful office suite software LibreOffice®: Support Writer (word processing), Calc (spreadsheet), Impress (PowerPoint), Draw (graphics and flow charts), Base (database and its front-end interface), and Math (mathematical editor).
- » Use Pinta for graphics drawing or photo editing: useful image editing software, support JPEG / JPG, Tiff, TGA, PNG, ICO, BMP and Open Raster, with more functions than Painter.
- » Text editor Emacs: highly extensible, very popular among programmers and other technology-oriented PC users.

Easily create continuous integration development environment

No need to memorize complicated program settings, through the popular apps in Container Station and with the one-click install feature, all settings are automatically and completely loaded, so that app developers can quickly and easily create integrated development environment.

✍ Recommended Quick Install applications: Private Registry, GitHub, Jenkins.

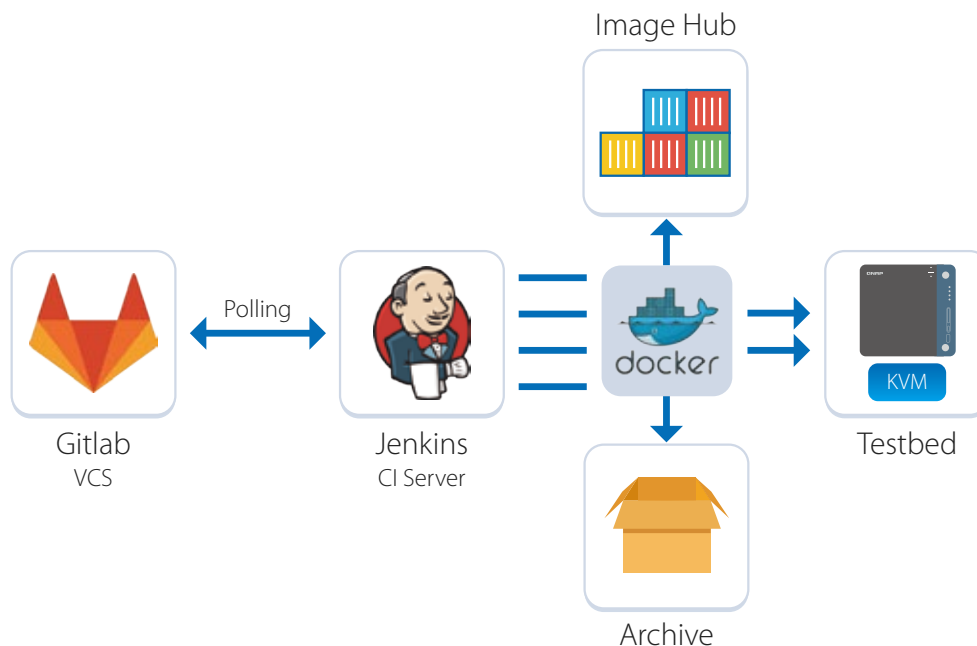

QIoT Containers - rapid development of an IoT private cloud

The IoT operational framework comprises the perception, network and application layers. Perception layer includes: objects to be detected, sensors, gateways and other components, which are used to identify the objects, and collect and transfer information to the network layer; the network layer is responsible for transmitting detected information to the application layer applications; the application layer is where various information are combined and visually presented, in order to meet the different business needs of enterprises.



IoT technology can be a confusing technology, but it is based on current sensors, networking and application software technologies. An enterprise only needs to further integrate and interconnect to achieve IoT.

Container apps designed specially for IoT

QIoT containers rapid development example: Container Station provides Ponte, Node-RED, MongoDB, Freeboard and other dedicated IoT software container, to facilitate easily creation of exclusive IoT environment for a developer. A typical IoT architecture combines sensors with the development versions available in the market (such as Raspberry Pi), Ponte(data receiving), Node-RED (data analysis), MongoDB (data storage) and Freeboard (data presentation) on QNAP NAS.

Container Station v1.6 provides

recommended IoT applications, such as:

- Kafka · RabbitMQ · MQTT · Freeboard
- Node-RED · Redis · MongoDB · Ponte
- Dashing · Freeboard

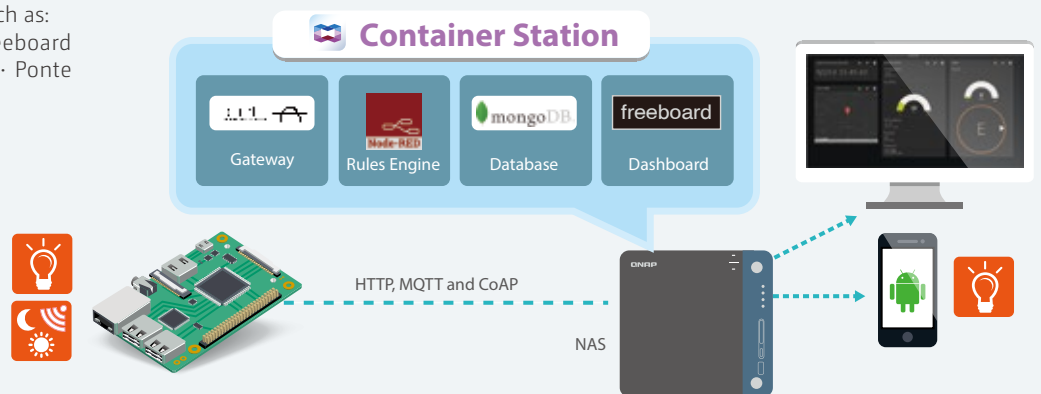

QButton- customize your button functions

The QButton built into QNAP remote controls can be combined with QTS App features, for you to easily enjoy the convenience brought by IoT. Combined with voice prompts, your convenience is greatly enhanced. Download QButton from the App Center, press the button and events you want, use a button to link up multiple QNAP applications, then you can get things done with a single key stroke.

QButton currently only supports the x73 series.

RabbitMQ Copyright © 2007-2016 Pivotal Software, Inc. All rights reserved
 Node-RED Copyright 2013, 2016 IBM Corp. under the Apache 2.0 license.
 freeboard is brought to you by Bug Labs, Inc. ©. All Rights Reserved.
 MongoDB Mongo, MongoDB, and the MongoDB leaf logo are registered trademarks of MongoDB, Inc.
 Kafka Copyright © Confluent, Inc. 2015. All rights reserved. Apache®, Apache Kafka, Kafka, and the ApacheKafka logo are either registered trademarks or trademarks of the Apache Software Foundation in the United States and/or other countries.





Turn NAS into a PC

QvPC technology

QvPC technology (QNAP Virtualized Personal Computer) is a result from the R&D efforts of QNAP following SDx (Software-defined Anything) trends through continuous development and improvement in software and hardware technology. With just a simple keyboard, mouse, monitor and other devices, you can turn NAS into a physical computer, making QNAP NAS a cost-effective and dual purpose machine.

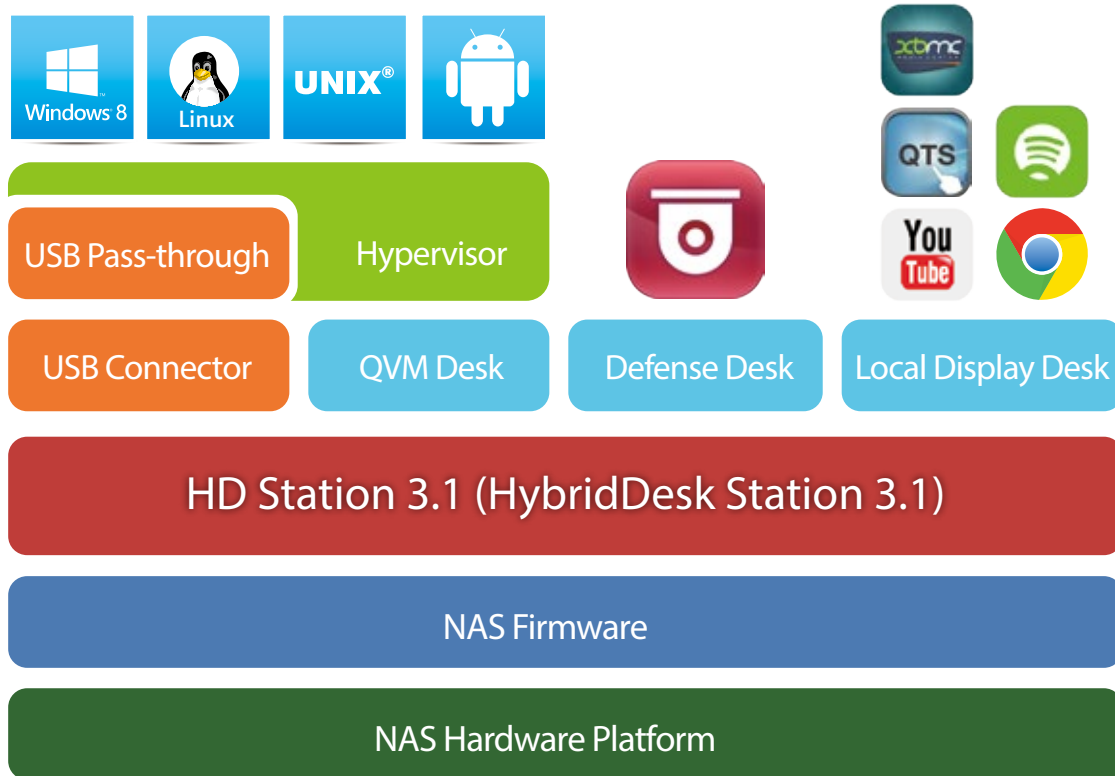

After purchasing a NAS, the next main step is to use the installation CD to install software and to find the NAS in the network, or connect to the vendor's web site for installation. For users with no network knowledge, the installation process may be difficult. QNAP NAS is clearly the best choice for storage. With QvPC technology users only need to connect the QNAP NAS to a keyboard, mouse and HDMI display and then follow the on-screen instructions to install and set up. It's just like using a PC, and even users with no network knowledge can quickly set it up. All files are protected through RAID data protection, and can be accessed through the Internet at any time.

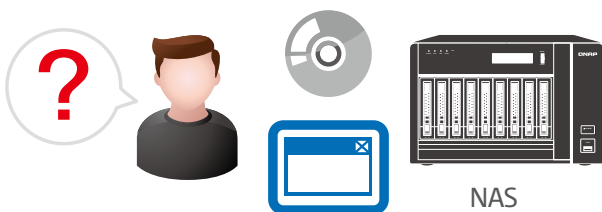

NAS Passive installation: Needs an installation CD or external Web page to install and set up. For the average user, it can be too complicated.

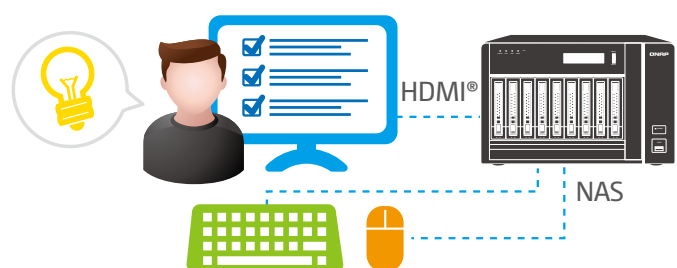

Streamlined installation: Simply connect a keyboard, mouse and HDMI display and follow the on-screen instructions to complete the installation.



Local output, fast and convenient HD Station 3.1

HD Station is very easy to use. By connecting the NAS to an HDMI display, you can enjoy a streamlined installation procedure with up to 4K video output *. This way, you not only avoid the complex setup of network media players, but you can also use your NAS as a Home Theater PC for direct multimedia enjoyment.

A wealth of apps

In addition to QNAP's own apps, HD Station supports a number of popular multimedia players (HD Player, Plex Home Theater, DeaDBeeF, Clementine), web browsers (Chrome™, Firefox) and other multimedia platforms (YouTube, Spotify, TuneIn Radio) to provide you with complete entertainment features.

Multilingual input and improved multitasking

HD Station supports multi-language input methods, allowing you to use your own language while searching through a browser. HD Station also supports multitasking. In the past, HD Station could only display one app at a time. Now users can switch between multiple apps for convenient and handy use.

✎ Not all models support 4K display.



Customizable remote control - no need to buy a dedicated remote control

HD Station provides remote control learning and memorizing functionality. With the ability to use your own remote controls, it can assist in reducing clutter in the living room. Just follow these two steps to pair an infrared remote control with HD Station.

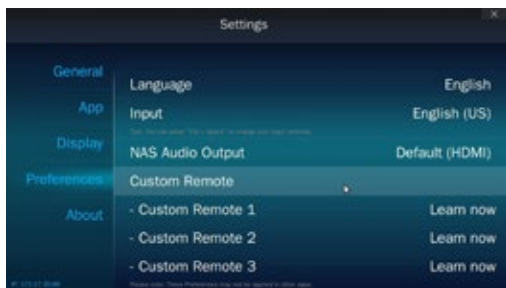

1. Go to [Settings]> [Preferences] in HD Station, find the Custom Remote option, and select Learn now.

2. Press the corresponding buttons on the remote control to pair it. When pairing, press and hold the corresponding button until the progress bar finishes.

✎ System requirements:

- »HD Station 3.1.1 (or newer) » Support a maximum of three custom remote controls
- »Some remote controls may not support this feature



Qremote - Easy to get started

In addition to keyboard, mouse, or QNAP remote control, you can also use the Qremote mobile app (for iOS and Android devices) to turn your mobile device into a remote control. Qremote offers four modes: app shortcuts, simple remote control, touch panel or keyboard mode, allowing you to enter text and operate in an easier manner.



Unique IoT private cloud platform

IoT applications



Developing innovative IoT applications becomes much easier

QIoT Suite Lite

QIoT Suite Lite supports multiple protocols and Dashboard control panel applications, so that developers can build their own IoT applications. With development board and sensors, Rules engine and Dashboard of QIoT Suite Lite, a developer can develop a variety of IoT applications.



IoT Applications

QIoT Suite Lite can help you quickly deploy a variety of IoT applications and help developers find various packages. QIoT Suite Lite can be used for user management, development board management, rules engine, dashboard setup, and more.

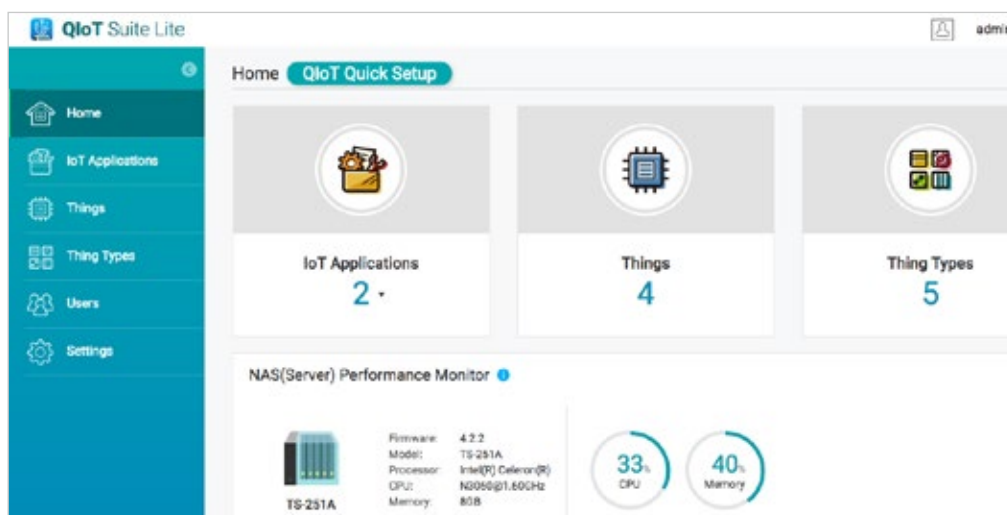

QIoT Suite Lite supports MQTT, HTTP and CoAP protocols, and provides MQTTs and HTTPs, so developers do not have to worry about connection security. QIoT Suite Lite can be used as an IoT center of a private cloud. It can also be used as a medium for other network services, such as wearables and smart home applications.

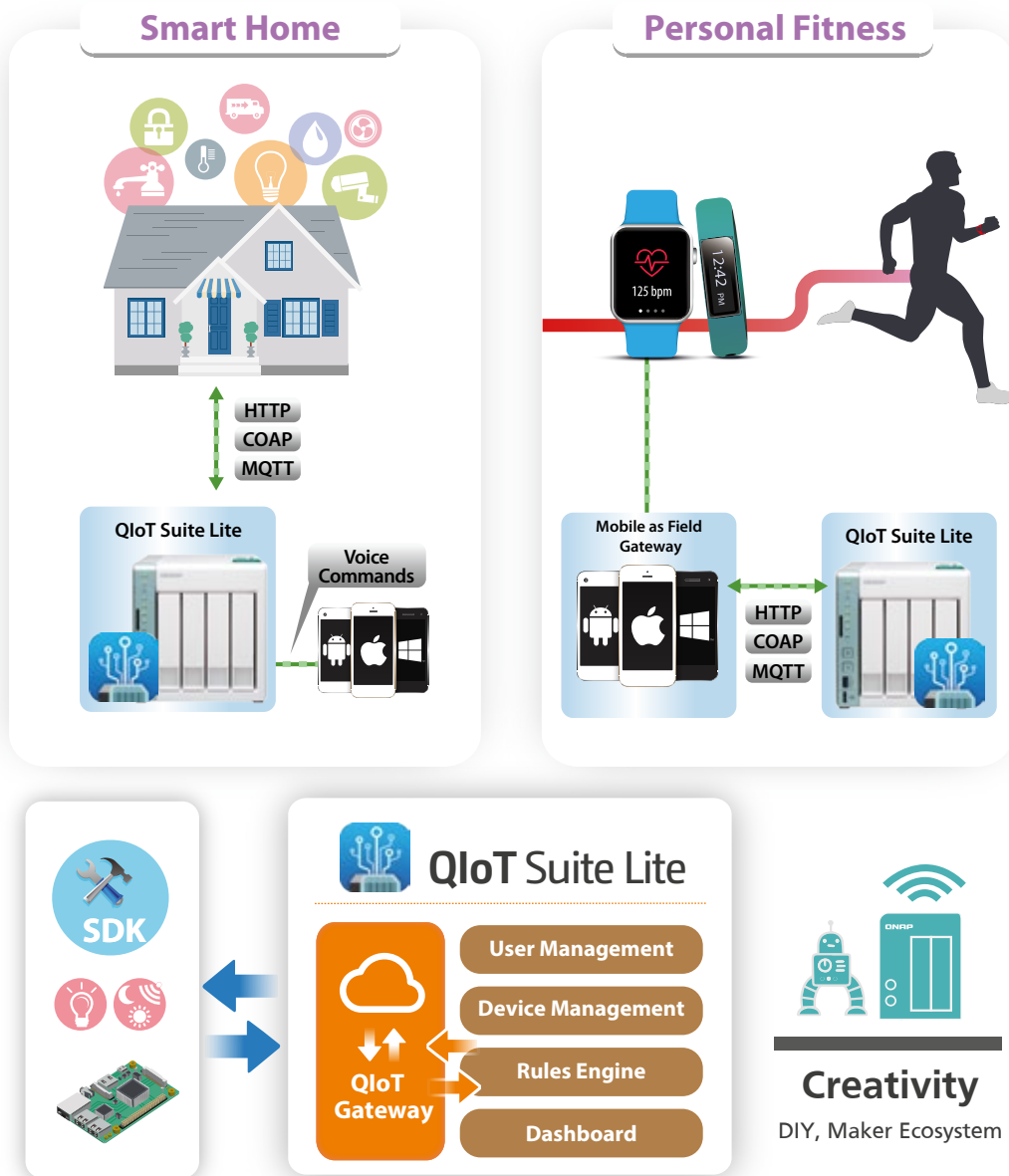

Rules Engine

NodeRED-based rules engine makes it easier to develop IoT applications, and QIoT Suite Lite provides custom nodes to help developers handle messaging and data presentation.



Dashboard

The built-in Dashboard shows development board and sensor information at a glance; the information can be presented in different ways, and can be output to Freeboard, Microsoft PowerBI and other information tools.



Create a 7x24 secure environment

Video Surveillance Solution



Professional video surveillance and management system

Surveillance Station 5.1

Surveillance Station is a professional video surveillance and management software.. Armed with IP cameras, QNAP NAS becomes a professional network surveillance system (NVR), providing complete real-time remote monitoring, recording, playback, intelligent video recording, alarm functions, intelligent analysis and management capabilities to protect your environment.

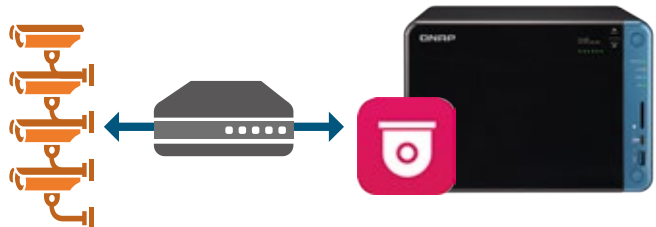

✍ For the camera compatibility list, please visit www.qnap.com

Layered and partitioned storage architecture

QNAP's multiple functions and architecture are based on a layered and partitioned structure. Through the storage pool storage architecture, you can distinguish between NAS and NVR, and save to different storage pools composed of different hard disks. In addition, you can also set dedicated network ports for NVRs to achieve the best read/write performance for coexisting NAS and NVR.

NAS dedicated storage pool for storing general files

NAS dedicated storage pool for storing video recordings

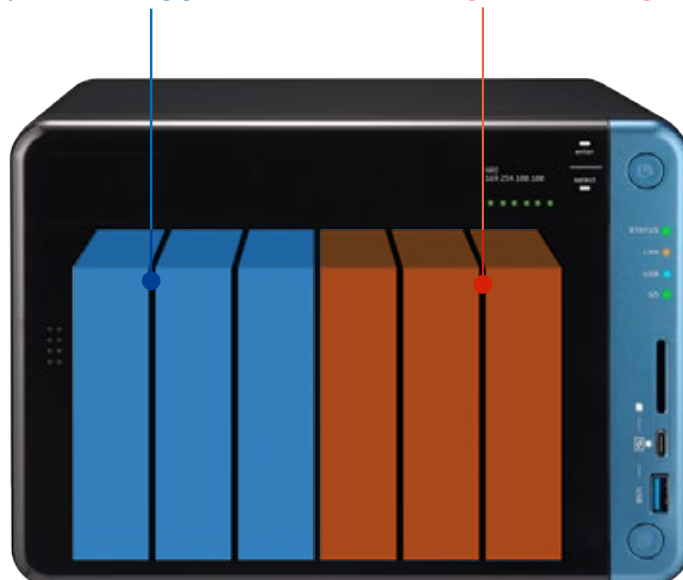

Quickly set up a professional surveillance system in three steps

1. Choose where Surveillance Station recordings are saved

recordings are saved

When first using the video surveillance center, you must specify where surveillance video should be stored. We recommend using a separate storage pool for storing video surveillance images.

✍ We recommend using hard drives specifically designed for NVR/ surveillance purposes. Please refer to www.qnap.com for the compatibility list.

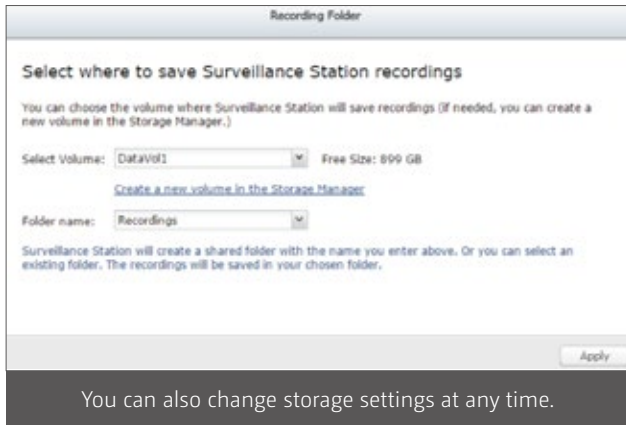

2. Camera settings

After you have connected the camera and confirmed that the camera and NAS are in the same network, click the [New] camera button, and the video surveillance center will automatically find the camera on the network.

✍ In addition to IP cameras, QNAP also provides other options. The QUSBCam App in the App Center allows using standard USB cameras. Next, with the same operation as with IP Cam, you can use the video surveillance center to record and playback videos.

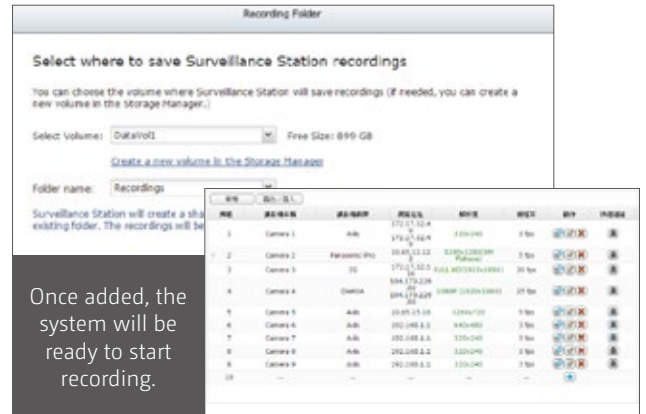

3. Start surveillance or playback video

The video surveillance center provides multiple ways for you to monitor or play recordings. You can click the surveillance footage, click playback button, or use Vmobile, mobile apps, or QvPC local display for monitoring.

✍ PC or Mac must have Client software installed before viewing. Click the monitoring or playback button to guide you through installation. A single PC Client software can be used to simultaneously log into different video surveillance centers to view multiple screens.

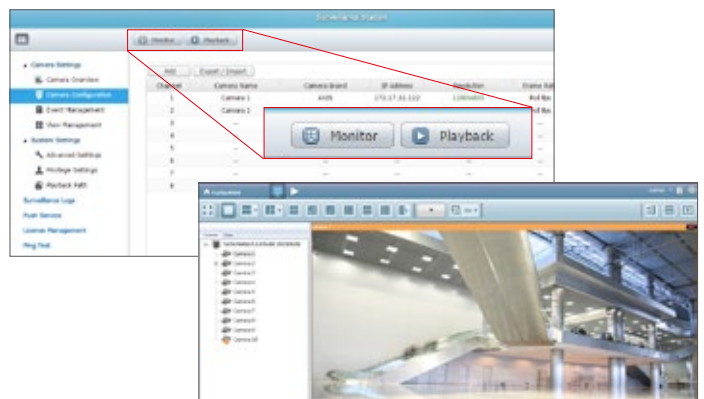

Never miss any recordings Playback path management

When changing the video location, the video surveillance center will automatically record the path of the old location in the playback path management table. With this feature, the video files stored in another folder can also be played back through the video surveillance center.

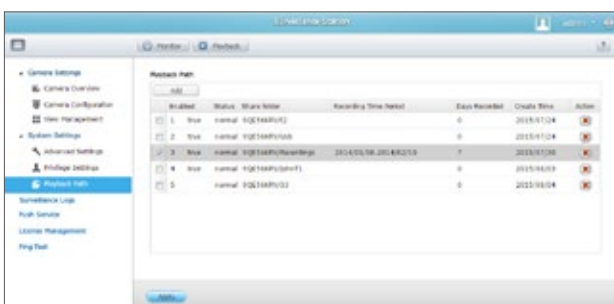

Automatic storage setting configuration

Video surveillance center has two-camera usage threshold default settings, and will not allow you to have less than 5% remaining storage space for videos, or exceeding 1TB of storage. Should you require a surveillance video storage space of more than 1TB on your hard disk, you can adjust the size of the designated space to suit your needs.

Upper and lower storage limits for fine-tuned administrative control

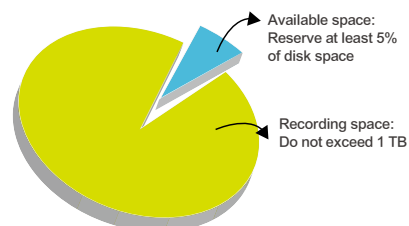

Flexible monitoring modes

Diverse layout choices for playback and monitoring

QNAP default settings provide a rich set of viewing modes, including 1,2,3,4,6,8,9,10,12,16,20,25,36,49,64 channel viewing modes. If these standard modes are unable to meet your monitoring requirements, you can also customize your desired layout using the layout management function.

✍ Click [Refresh] to view the layout immediately after adjustment.

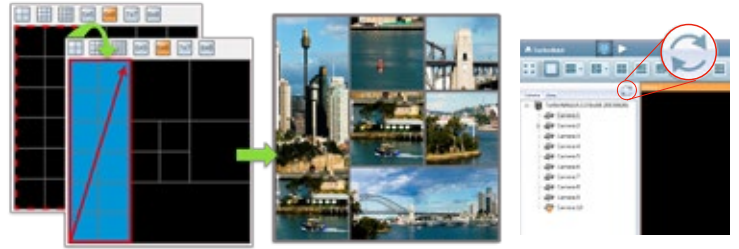

Virtual cameras

When using high-resolution cameras to cover a wide area, you can take advantage of virtual cameras to highlight areas you want continuous attention to. Virtual cameras do not need authorization. They may also be included in customized versions to show in conjunction with the general camera.

Fast forward, rewind, adjust speed, and frame-by-frame playback

Using the shuttle button, you can drag right or left, drag forward or backward to quickly and easily find desired frames, at the speed you want. When it's near the event, you can change to frame view to check details about the event.



PTZ controls

You can control the network camera, moving it up and down or zooming in and out, through the PTZ (Pan / Tilt / Zoom) feature in Surveillance Station. You can also enable the Click Go function to select the location you want to set and make it more convenient for remote monitoring.

✍ Video Surveillance Center 5.1 features a digital watermark tool that displays the exact recording date and time, camera name, and QNAP NAS model to verify the authenticity of the output video or snapshot.

QNAP General Fisheye Reduction (Qdewarp)

Fisheye lens are ideal for spacious places. Using image restoration technology, users will be unaffected by the distortion and will be able to see the image details. Qdewarp is compatible with all supported fisheye cameras. You can select the camera type you want to view in the restored video layout, and move the restored area at any time. Qdewarp supports real-time monitoring and recording playback, and ensures there are no blind spots.



Immediate alerts for events

Set alerts and notifications

When cameras detect motion or alerts are triggered, Surveillance Station will automatically send notifications to up to 5 email addresses.

Region of Interest

In comparison with traditional analog surveillance cameras, high-definition IP cameras can cover a much wider area. QNAP Remote Control provides options to quickly setup areas of interest. You can select a 5 or 7 split-area from the full image to focus in order to see more details, and monitor and manage the focus area without requiring additional camera licenses.

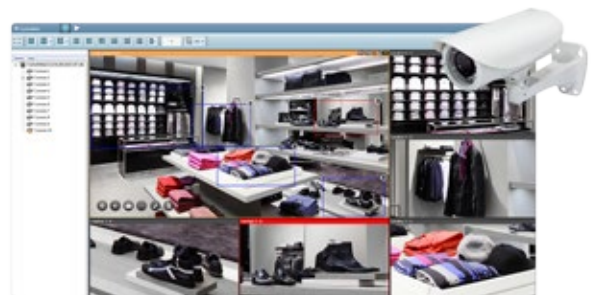

Show camera location status on a map

After the images of the area under surveillance are uploaded to the Surveillance Station, drag and drop the camera icon onto the installation site. In event of an alarm, the camera icon will flash in warning. Click the icon to view real-time images, or take necessary actions.

 Independently-controlled monitoring environment
QVR Pro

QVR Pro is a video surveillance solution that integrates existing QVRs into QTS. It allows you to have exclusive video storage space and operating environments with a separate machine, and enjoy QTS expanded video storage space as well.

Perfect integration of software and hardware

Professional NVR surveillance software + powerful NAS platform



Single surveillance playback interface

In the same interface, you can see real-time footage from multiple cameras and play recordings without needing to switch between real-time footage and video playback. If you notice any suspicious activity, just click on the image to play the footage from any time to quickly investigate.

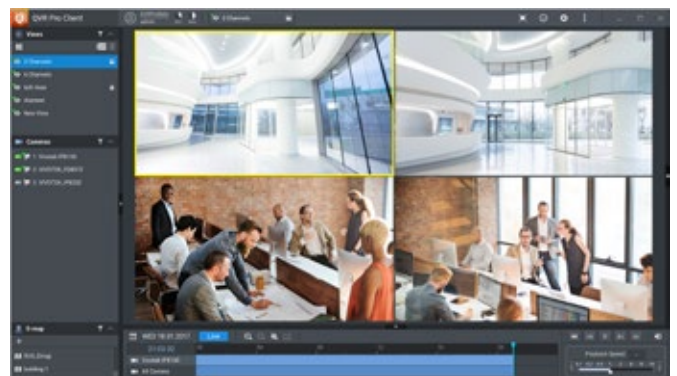

Flexible monitoring modes

QVR Pro Client can intuitively drag multiple cameras or electronic maps to the screen and easily adjust the layout size and position. The highly flexible and customizable layout perfectly suits various monitoring scenarios.

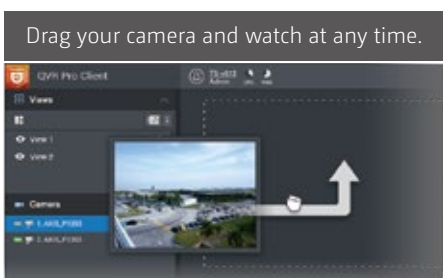

✍ Support three kind of system platforms: Windows®, Mac®, HD Station.

Independent operating environment

QVR Pro reserves exclusive storage space in advance, so even if it shares the same NAS or the same storage pool with QTS, it can still save files independently, with independent video storage space while enjoying the QTS storage management at the same time.



Expand anytime, no more worries about storage capacity

Expand at any time with no fear of insufficient capacity

The video storage space of QVR Pro can be spread across multiple disk volumes. Even if the NAS storage capacity is full, you can expand the existing storage space through SAS, JBOD, USB JBOD, Thunderbolt™ JBOD, VJBOD and other mediums and flexibly configure storage settings, making long-term video recording more convenient and more scalable.

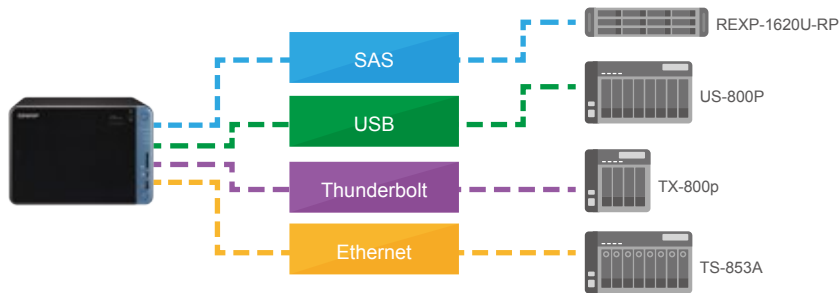

Backup disk volume, uninterrupted video recording

You can include multiple disk volumes into the recording storage space to continue recording without interruption. Even if one of the recording storage spaces is damaged, it won't affect saving the full video.



Layered storage, maximizing hardware performance

QVR Pro can set up different video storage spaces for different video applications. You can save high-quality 4K video recordings to SSD storage to keep applications such as event recordings or areas of interest (ROI) clear, maximizing hardware performance without compromising image quality.

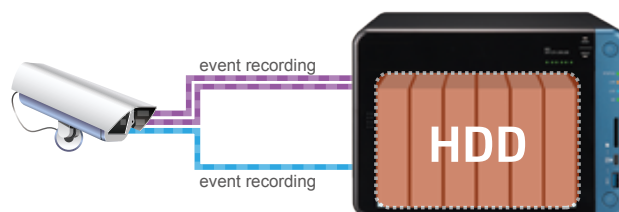

Batch add/edit cameras

Compared to adding/editing cameras one by one, they can be added/edited in batches to reduce the time and labor costs associated with setting up and maintaining a monitoring system.



Search across the network and add cameras

Due to protocol limitations, automatic camera searching in the past was limited to the local NAS network. However, with QVR Pro, if there are connected networks, you can just enter the network you want to search on. QVR Pro will automatically search for cameras in that network. This significantly reduces the time it takes to add new cameras and also reduces the labor cost of installing cameras from a designated vendor.

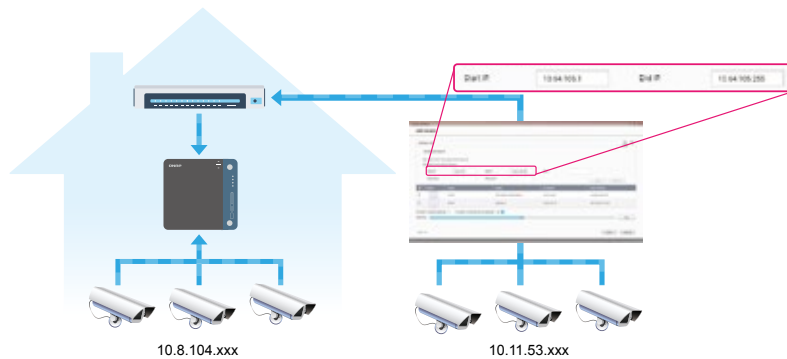

Simultaneously record multiple videos with multiple resolutions

QVR Pro supports the simultaneous recording of multiple video streams, including concurrent recording of high-definition and standard-definition videos. This provides videos for variable connection qualities, for example, using high-quality recordings on Intranet connections and lower-quality videos for when using mobile devices or slow Internet connections. This assists in making playback smoother while optimizing bandwidth usage. In addition, when you need to play videos with a different resolution, no CPU encoding will be required from the NAS. This allows the NAS to focus on recording and enhances video stability.

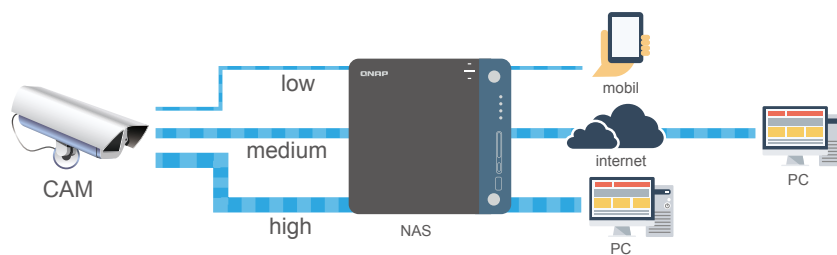

QVR Pro Client for Mobile

QVR Pro supports viewing and playing back camera footage on mobile devices using the QVR Pro Client mobile app. It also supports multi-stream playback, PTZ camera controls and event notification.





QUSBCam2— A handy surveillance tool

The new QUSBCam 2 supports Onvif and RTSP

The new QUSBCam2 turns a USB webcam into a network camera with Onvif standards and RTSP streaming protocol support. With Surveillance Station, you can monitor and view the USB camera output via QUSBCam2. You can quickly set up a home video surveillance system without any hassle, and record and monitor via the USB camera video and sound.

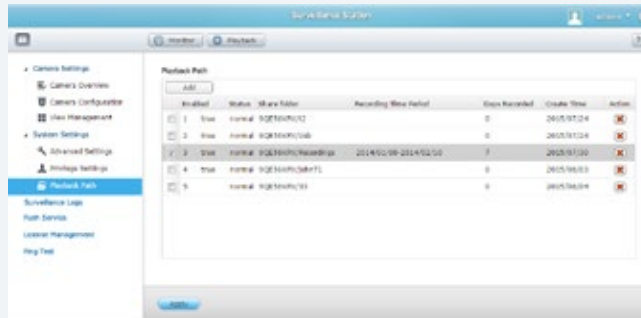

Supports hardware transcoding (CodexPack) to reduce CPU load

Through hardware transcoding, QUSBCam2 can effectively reduce CPU dependencies, so that your NAS has more resources for other operations. Due to its support for hardware encoding, QUSBCam2 can have up to 4 USB cameras, making it possible for you to use them in more ways.

- ✍ For a list of compatible USB cameras for QUSBCam2, refer to the QNAP compatibility list.
- ✍ The performance of a web page directly opening video surveillance may be affected by various factors (such as the video stream being used by other clients, or if the camera supports MJPEG).



Vmobile - professional action monitoring

Connect with your video surveillance system anytime, anywhere, and immediately view the surveillance camera screen.

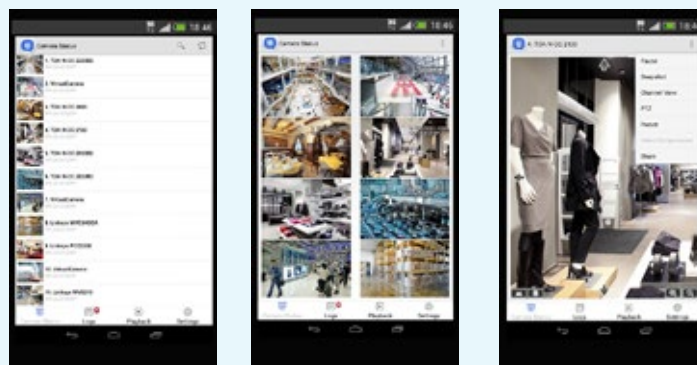

✍ Support: iOS®, Android™ devices.

Profile management

Create multiple profiles with different sets of VioStor NVR/QNAP NAS and IP cameras, and efficiently switch between different monitoring views from the profile list.

Low bandwidth mode

You can select this mode to view smoother images if your network is slow or congested. The recording quality is not affected by this mode.

PTZ control and preset position control

If your webcam supports PTZ controls, you can easily control your webcam to turn to a different angle remotely through your mobile device and monitor specific areas with a specific preset function.

Immediate event notification

If an event occurs, Vmobile can notify you via sound, vibration or push notifications, so you can take immediate action.



Enjoy NAS rich features

QNAP Bonus Applications



Customize your QNAP NAS for endless possibilities

App Center

Extend the functionality of your QNAP NAS to enrich your work and home life. The QTS App Center provides various install-on-demand apps to meet needs ranging from cloud backup/sync, home entertainment, business applications, to creating a surveillance center.

Newly-designed App Center interface

The App Center has been redesigned to be simpler and easier to use. Search by category, by keyword, or try an app recommended by QNAP. The App Center now supports multiple languages to cater to your language preferences. Alternatively, view the apps in list mode to get detailed information on the apps.

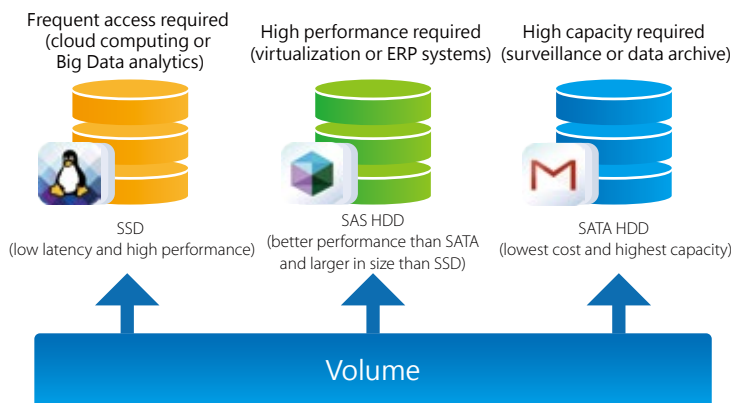

Layering and zoning for efficient resource allocation

Leveraging the tiered storage architecture of QNAP NAS, applications can be installed on specific volumes or freely migrated between different volumes. This allows administrators to manage applications flexibly based on performance and capacity requirements. For example: Frequently-accessed apps can be installed on SSD volumes and apps requiring high-performance can be installed on SAS volumes for optimal performance and space efficiency.

The feature is only supported by some apps.

Value-adding apps to widen your horizons

The App Center provides over 100 apps in several categories including Backup and Synchronization, Business, Content Management, Communication, Developer Tools, Download, Entertainment, Surveillance, and general purpose tools. Download apps from the QTS App Center to customize your NAS to suit your needs. Alternatively, download and deploy apps from public repositories for use in Container Station or Virtualization Station.

Enjoy NAS rich features

Application tools



Qfinder Pro

Qfinder Pro lets you quickly search, connect, and install QNAP NAS on your network. It supports all platforms, so you don't need to worry about how to connect after NAS installation. You only need to download and install the application. Qfinder Pro will automatically search for QNAP NAS within the LAN, and you can then double-click the NAS to connect to the QTS system.

✍ Support: Windows, Mac, Linux, Chromebook, and Chrome browser.

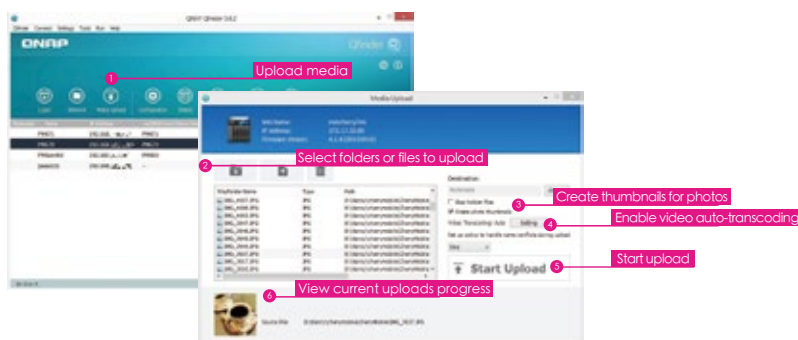

Easy access through Storage Plug & Connect

The Windows version of Qfinder Pro provides a convenient way to access QNAP NAS, connected network drives, or virtual disks. Use Qfinder Pro to create a shared folder on the NAS and connect it to a network drive, you can then use it as extra storage space, just as you would with a local disk.

Qfinder Pro video upload

Qfinder Pro not only helps you quickly find QNAP NAS in the LAN and connect to network drives, it can also automatically generate thumbnails during video uploads to save NAS system resources.

myQNAPcloud Connect

myQNAPcloud Connect is a VPN connection software designed for Windows users. It supports all VPN connections (including L2TP / IPsec, PPTP and OpenVPN) on the NAS. Users can establish a VPN connection with the NAS and connect to other QNAP NAS in the LAN to provide entry window for each service and manage the files easily by dragging and dropping.

✍ Support: Windows, Mac operating system.



Qsync

Qsync supports Windows and Mac and provides file synchronization between multiple computers. You can drag files into the Qsync folder to easily sync files across devices, such as computers and mobiles. For more details, refer to Qsync Central Station 2.0.

✍ Support: Windows, Mac operating system.





NetBak Replicator

The free QNAP NetBak Replicator allows you to easily back up files, photos, music, movies, fonts, and emails from a Windows PC to QNAP NAS. With simple operation, you can complete real-time backup, scheduled backup and automatic backup with just a few clicks. NetBak Replicator also supports FTP and WebDAV to back up to remote servers.

✍ Support: Windows only.



Q'center Virtualization Solution

Q'center is a powerful application for managing multiple QNAP NAS, whereas the Q'center virtualization solution can use Q'center as a virtual application built into a virtual environment (such as Microsoft® Hyper-V® or VMware® ESXi™). This solution makes Q'center more flexible as it can be used in large networked storage environments.

✍ Support: Windows only.

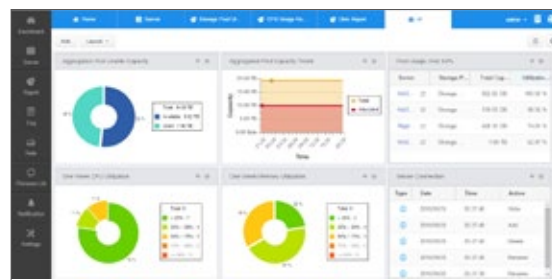

QNAP Snapshot Agent

When you set up an iSCSI LUN on Windows Server or VMware vCenter, you can use QNAP Snapshot Agent to take a iSCSI LUN snapshot that is consistent with NAS applications.



vSphere Client plug-in

QNAP NAS supports vSphere Client Plug-in and allows administrators to directly manage VMware storage pools (datastores) on QNAP NAS from the vSphereClient console. In large-scale server virtualization environments, virtual host management can become more centralized and easier. Administrators can easily control QNAP NAS and storage clusters, and can quickly create storage pool clusters across multiple ESXi virtual hosts with just a few clicks.

✍ Support: Windows only.



Qsnap

Qsnap helps you quickly capture your computer's screen and easily edit, archive, and share it, making it a great helper to quickly take notes and improve communication both at home and at work.

Hotkey screenshot: take screenshots with hotkeys, without needing a mouse. Quick edit: edit, mark, annotate, or remove unnecessary elements from multiple images.

Instant share: drag the screenshot to your communications software or email as an attachment and share it right away.

✍ Support: Windows only.

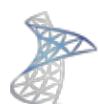

QNAP SMI-S provider

QNAP SMI-S provider allows administrators to manage QNAP NAS directly through Microsoft System Center Virtual Machine Manager 2012 (SCVMM).



Smart life anytime, anywhere

Mobile Apps & Utilities



Qfile - Easily access and manage files

Remotely manage QNAP NAS files, upload and download, stream videos / music instantly, share files easily, and automatically sync files from mobile devices.



Qmusic - Mobile music library

You can now stream music stored on a QNAP NAS for a mobile music library, taking your music collection wherever you go.



Qmanager - Remote monitoring and management

You can remotely query your system logs and connection logs from your mobile device, and remotely manage your QNAP NAS (for example, shut down or reboot, locate the position of QNAP NAS, etc.). Qmanager 2.0 also supports the secure removal of external devices, making it easier to manage QNAP NAS.



Qvideo- a mobile cinema

Qvideo is a free mobile video management tool designed for Video Station. It allows you to play videos on the QNAP NAS at any time and from anywhere, or share your favorite movies with friends and family. If you are accustomed to using Video Station, you don't need to learn anything new. Just open Qvideo and enjoy the videos.



Qphoto - Mobile photo gallery

Still worried about insufficient mobile storage capacity? Do you have photos taken with a professional camera yet you are unable to share with friends because the files are too big, and can only save the photos in a computer? Now, you can just store your photos on a NAS, then even RAW photos can be easily viewed on your mobile device and instantly shared with your friends. No more fear of large photos and insufficient storage.



Qnotes - Portable notes

Qnotes is a high-efficiency, high-privacy Note app, and is the only Android™ Note app to support private clouds. Qnotes can synchronize data with other devices via QNAP NAS, but also supports stand-alone operation. In stand-alone mode, Qnotes can be used without any NAS or network connection.



Qget - Remotely manage download tasks

Through Qget, you can easily view and manage the status of all download tasks (including starting, pausing or removing download tasks). When downloading is complete, you receive notification from Qget, so you are informed of the current status of all download tasks.



QmailClient

Email services can also be accessed through iOS® and Android™ devices. The system will automatically push new messages to your device, so you can immediately know the latest news. Using QmailClient, you can also save your latest emails to your mobile device for offline reading.



Vcam 1.0

With Vcam, you can use your device's camera to record your surroundings to your QNAP NAS, saving you the extra cost of purchasing a professional webcam.



Qremote - Proprietary mobile remote control

Qremote is a remote control specifically designed for HD Station. As long as the mobile phone is paired with the NAS, you can easily operate your NAS without needing to connect a keyboard or mouse.



Vmobile - Professional action monitoring

Vmobile can help you connect with your video surveillance system anytime, anywhere; immediately view the surveillance camera screen; and immediately receive notifications of events and conditions.



OceanKTV Client

Simply connect your mobile device to the same network as the NAS and download the OceanKTV Client, then you will be able to directly log into OceanKTV and start singing.



Qsync client

Simply connect and select files to browse on the NAS. You can also easily move, copy, rename, or delete files in NAS without needing a computer.



Qcontactz

With the Qcontactz mobile app you can quickly import contacts from your phone to your QNAP NAS. You can also set a schedule for synchronization with the NAS.



Expansion Units, Optional Accessories, and Expansion Cards

Hardware Specifications



Ordering SKUs	TS-653B-8G	TS-653B-4G	TS-453B-8G	TS-453B-4G	TS-253B-8G	TS-253B-4G
CPU	Intel® Celeron® J3455 quad-core 1.5 GHz, up to 2.3 GHz					
Encryption Acceleration Engine	✓ (AES-NI)					
Graphics	Intel® HD Graphics 500					
Pre-installed Memory	8GB DDR3L (2 x 4GB)	4GB DDR3L (2 x 2GB)	8GB DDR3L (2 x 4GB)	4GB DDR3L (2 x 2GB)	8GB DDR3L (2 x 4GB)	4GB DDR3L (2 x 2GB)
Maximum Memory	8GB					
Memory Slots	2 x DDR3L SODIMM slot (For dual-DIMM configurations, you need to install a pair of DDR3 memories with the same speed, capacity, and chip)					
Drive Compatibility	6 x 3.5"/2.5" SATA 6Gb/s HDD/SSD		4 x 3.5"/2.5" SATA 6Gb/s HDD/SSD		2 x 3.5"/2.5" SATA 6Gb/s HDD/SSD	
Gigabit LAN Ports	2 x Gigabit RJ45 LAN ports					
10GbE LAN Port	Optional: 10GbE PCIe network expansion card					
USB 3.0 Ports	5 x Type-A ports					
USB QuickAccess	USB Type-C					
PCIe Slot	1 x PCIe 2.0 x2 slot					
HDMI Outputs	2, up to 3846 x 2160, 30 Hz					
Audio	2 x 3.5 mm dynamic microphone jacks, speaker, 3.5 mm line-out jack					
OLED Panel	0.96" monochrome OLED panel					
LED Indicators	status / power, network, USB, hard drive, SD memory card, USB QuickAccess					
Button	Power / status, USB one-button backup, system reset, capacitive touch key (confirmation key and selection key)					
Infrared (IR) Receiver	✓, comes with RM-IR004 remote control					
Other slots	SD memory card reader, Kensington security slot					
Dimensions (H x W x D)	168 x 235 x 226 mm 6.61 x 9.25 x 8.90 inch		168 x 170 x 226 mm 6.61 x 6.69 x 8.90 inch		168 x 105 x 226 mm 6.61 x 4.13 x 8.90 inch	
Net Weight	3.01 kg (6.64 lbs)		2.33 kg (5.14 lbs)		1.66 kg (3.66 lbs)	
Operating Temperature	0 to 40°C (32°F to 104°F)					
Power Consumption	HDD sleep: 20.62W Normal operation: 40.33W		HDD sleep: 15.00W Normal operation: 30.04W		HDD sleep: 13.07W Normal operation: 20.42W	
Power	120W AC adapter, 100-240V		90W AC adapter, 100-240V		65W AC adapter, 100-240V	
Fan	2 x 9cm		1 x 12cm		1 x 7cm	

Software Specifications

Supported disk group types	TS-253B: RAID 0/1, single, JBOD; TS-453B: RAID 0/1/5/6/10, RAID 1/5 + spare, single, JBOD; TS-653B: RAID 0/1/5/6/10, RAID 1/5/6/10 + spare, single, JBOD
Storage Manager	Flexible disk area and LUN configuration; storage pool online RAID capacity expansion and configuration migration
Supported client systems	Windows 7, Windows 8, Windows 10, Windows Server 2003/2008 R2/2012/2012R2, Apple Mac OS 10.6+, Linux & UNIX
Internal file system	EXT4
External file system	EXT4, EXT3, NTFS, HFS+, FAT32, exFAT (Need to purchase additional exFAT software license)
Supported protocols	CIFS/SMB, AFP (v3.3), NFS(v3), FTP, FTPS, SFTP, TFTP, HTTP(S), Telnet, SSH, iSCSI, SNMP, SMTP, and SMC
File sharing	Maximum number of users: 4096; Maximum number of user groups: 512; Maximum shared folder: 512; Maximum number of simultaneous connections: 800
Video Surveillance	Surveillance Station contains 4 free camera channel licenses. You can purchase additional licenses to expand to a maximum of 40 channels (http://license.qnap.com)
Other Features	File Station, Photo Station, Music Station, Video Station, Download Station, Qsync, Notes Station, HD Station, FTP server, printer server, VPN server / client, Qtier, anti-virus protection, Qsirch, Qcontactz, QmailAgent, Qfiling
Streaming Server	DLNA server, Airplay, Chromecast, iTunes server
Video Playback and Transcoding	Equipped with hardware acceleration chip, support up to 4K H.264 audio and video transcoding
Remote access	myQNAPcloud

Accessories

Type	Ordering SKUs	Description
Expansion Units	UX-800P	QNAP 8-bay expansion unit
	UX-500P	QNAP 5-bay expansion unit
Memory	RAM-2GDR3LA0-SO-1866	2GB DDR3L 1866MHz SODIMM RAM
	RAM-2GDR3L-SO-1600	2GB DDR3L 1600MHz SODIMM RAM
	RAM-4GDR3LA0-SO-1866	4GB DDR3L 1866MHz SODIMM RAM
	RAM-4GDR3L-SO-1600	4GB DDR3L 1600MHz SODIMM RAM
M.2 SSD	SSD-M2080-256GB-A01	256GB M.2 2280 SATA 6Gb/s SSD (Need to use QM2 expansion card)
Expansion Card	QM2-2S	Supports two M.2 2280/22110 SATA SSDs
	QM2-2P	Supports two M.2 2280 / 22110 PCIe SSDs
	QM2-2S10G1T	Supports two M.2 2280 SATA SSDs and provides a single port 10GBASE-T 10 GbE network port
	QM2-2P10G1T	Supports two M.2 2280 PCIe SSDs and provides a single port 10GBASE-T 10 GbE network port
	LAN-10G1SR	Single-port 10GbE SFP+ NIC
LAN-10G2SF-MLX	Single-port 10GbE SFP+ NIC	
LAN-10G2T-X550	Single-port 10GbE 10GBASE-T NIC	
Remote Control	RM-IR004	Infrared Remote Control (included)

Package Contents

NAS, Quick Installation Guide, AC power adapter, power cord, Ethernet cables, remote control, screws for 2.5-inch drives

*Please visit www.qnap.com for more hardware and software specifications. Design and specifications are subject to change without notice.

Software Specifications

Operating System

- QTS 4.3 (embedded Linux)

Supported Client OS

- Windows 7, Windows 8, Windows 10, Windows Server 2003/2008 R2/2012/2012R2
- Apple Mac OS 10.7+
- Linux & UNIX

Supported Browsers

- Microsoft Internet Explorer 10+
- Google Chrome
- Apple Safari 7+
- Mozilla Firefox

Multilingual Support

• Chinese (Traditional & Simplified), Czech, Danish, Dutch, English, Finnish, French, German, Greek, Hungarian, Italian, Japanese, Korean, Norwegian, Polish, Portuguese (Brazil), Romanian, Russian, Spanish, Swedish, Thai, Turkish

File System

- Internal Hard Drive: EXT4
 - External Hard Drive: EXT3, EXT4, NTFS, FAT32, HFS+, exFAT*
- *exFAT is optionally purchased by App Center

Network & Virtual Switch

- TCP/IP (IPv4 & IPv6: Dual Stack)1
- Jumbo frame (failover, multi-IP settings, port trunking/NIC teaming)
- DHCP client, DHCP server
- USB Wi-Fi Adapter Support
- Virtual Switch
 - Supports editing the Virtual Switches in Virtualization station.
 - Supports combining virtual machines and containers to the same Virtual Switch.
 - Supports NAT (Network Address Translation).
 - Supports STP (Spanning Tree Protocol).
- USB QuickAccess
- WirelessAP Station

Security

- Network access protection with auto-blocking: SSH, Telnet, HTTP(S), FTP, CIFS/SMB, AFP
- CIFS host access control for shared folders
- FIPS 140-2 validated AES 256-bit volume-based and shared folder data encryption2
- AES 256-bit external drive encryption*
- Importable SSL certificates. Supports certificates from Let's Encrypt.
- Instant alerts via email, SMS, beep, push service, and OLED panel
- 2-step verification

Storage Management

- Storage Space Utilization monitoring
- QNAP flexible Volume/LUN with thin provisioning and space reclaim
- Disk volume types
 - 2-Bay: RAID 0, 1, JBOD, single
 - 4-Bay: RAID 0, 1, 5, 6, 10, 5 + hot spare, JBOD, single
 - 6-Bay: RAID 0, 1, 5, 6, 10, + hot spare, JBOD single
- Supports storage pools
- Supports Qter™ auto-tiering technology
- Supports snapshots
 - Supports Volume/LUN snapshot
 - Snapshot manager
 - Snapshot clone
 - Snapshot vault
 - Snapshot replica
 - Snapshot agent for Microsoft Windows and VMware vSphere
- Online volume expansion
- Online storage pool expansion
- Online RAID capacity expansion and online RAID level migration
- SMART data migration
- Storage expansion via QNAP UX-500P/UX-800P expansion units
- JBOD enclosure roaming
- SSD read-only/read-write cache
- Bad block scan and hard drive S.M.A.R.T.
- Bad block recovery & RAID recovery
- Bitmap support

Power Management

- Wake on LAN
- Internal hard drive standby mode
- Scheduled power on/off
- Automatic power on after power recovery
- USB and network UPS support with SNMP management

Access Right Management

- Batch user creation
- Import/Export users
- User quota management
- Local user access control for CIFS, AFP, FTP, and WebDAV
- Application access control for Photo Station, Music Station, Video Station, and File Station
- Subfolder permissions support for CIFS/SMB, AFP, FTP, and File Station

Domain Authentication Integration

- Microsoft Active Directory (AD) & Domain Controller support
- LDAP server, LDAP client
- Domain user login via CIFS/SMB, AFP, FTP, and File Station

myQNAPcloud Service

- Private cloud storage and sharing
- Free host name registration (DDNS)
- Optional myQNAPcloud SSL certificates (DDNS)
- Auto router configuration (via UPnP)
- Web-based file manager with HTTPS 2048-bit encryption
- CloudLink for remote access without any complicated router setup
- myQNAPcloud connect for easy VPN connection (Windows VPN utility)

Qsync

- Sync files across multiple devices with SSL secure connection
- Selective synchronization for only syncing specific folders
- Use team folders as a file center for greater team collaboration (maximum sync tasks: 32)
- Shares files by links via e-mail
- Policy settings for conflicting files and file type filter support
- Version control: up to 64 versions.
- Supports central configuration mode
- Supports remote erase/restore
- Supports Windows & Mac OS

Resource Monitor

- Monitor NAS system resources including CPU, memory and network
- Monitor NAS storage resources including volumes, RAID, and disk activity.
- Monitor the resource usage of NAS applications
- An extra swap space will be created if SSD is added to the NAS.Swap space on SSDs is prioritized over swap space on HDDs because of the greater speeds of SSDs

Helpdesk

- Report issues to the QNAP support team, with automatically collected system information
- Allows QNAP support engineers to remotely connect to the NAS to fix issues (with user permission)

Web Administration

- Multi-window, multi-tasking based system management
- Smart toolbar and dashboard for neat system status display
- Dynamic DNS (DDNS)
- SNMP (v2 & v3)
- Resource monitor
- Network recycle bin for file deletion via CIFS/SMB, AFP, and File Station
 - Automatic Cleanup
 - File Type Filter
 - Comprehensive logs (events & connection)
 - Syslog client/server
 - System settings backup and restore
 - Mobile app: Qmanager for remote system monitoring & management

File Server

- File sharing across Windows, Mac, and Linux/UNIX
- Microsoft networking
 - Windows ACL
 - Advanced folder permissions for CIFS/SMB, AFP, FTP
 - Shared folder aggregation (CIFS/SMB)

FTP Server

- FTP over SSL/TLS (Explicit)
- FXP support

File Station

- Supports mounting cloud drives (such as Google Drive, Dropbox, Microsoft OneDrive, Microsoft OneDrive for Business, HiDrive, Amazon Cloud Drive, Yandex Disk and Box)
- Supports mounting remote shared folders through FTP, WebDAV or Microsoft networking (SMB/CIFS)
- Supports opening documents via Office Online, Google Docs or Chrome Extension (Edit Office files in Google Docs, Sheets, and Slides)
- Supports ISO Mounting (Up to 256 ISO Files)
- Supports sharing download links and upload links
- Drag-n-drop Files via Chrome and Firefox Browsers
- Photo, music, and video preview and playback with hardware-accelerated transcoding3
- File Compression (ZIP or 7z)
- Creation of and sending download links for sharing public files with expiration date and password protection
- Supports displaying subtitles (*.SRT, UTF-8 format)
 - Video seeking support for video playback during on-the-fly transcoding3
 - Supports slideshow playback in media viewer
- Mobile App: Qfile for file browsing and management

Qfiling

- Supports auto filing

Transcode Management

- Transcode video files to 240p, 360p, 480p, 720p and 1080p resolution
- Automatic video transcoding for watched folders
- Hardware accelerated transcoding support3
- Embed subtitles into videos for background transcoding

Hybrid Backup Sync

- Support for Amazon S3, Amazon Glacier, Microsoft Azure, Google Cloud Storage, Openstack Swift, and WebDAV
- Syncing with Microsoft OneDrive, Google Drive, Dropbox, Amazon Drive, Yandex Disk, Box, and hubiC
- Works as both RTRR server & client with bandwidth control
- Rsync server functionality with download bandwidth control
- Syncing with remote servers through RTRR, Rsync, FTP, and CIFS/SMB
- Scheduled backup to local and remote storage spaces
- Backup versioning for RTRR
- Encryption, compression, and file filters
- Centralized management for backup, restoration, and sync jobs
- Support for Apple Time Machine
- Data backup to multiple external storage devices
- Desktop backup with QNAP NetBak Replicator for Windows®
- Third party backup software support: Veeam backup & replication, Acronis True Image, Arcserve backup, emc retrospect, Symantec Backup Exec, etc.

Cloud Drive Sync

- Multiple cloud account management like Google Drive, Dropbox, OneDrive, and hubiC
- Supports multiple cloud accounts
- Manual, scheduled, periodic and continuous sync
- Flexible file filtering using type, date, and size
- SSL transfer encryption
- Dashboard and job statistics
- Configurable network error recovery options
- Extensive job activity logging for tracing history of status and statistics
- Concurrent job execution and multi-threaded data transfer
- Per-account bandwidth throttling

Cloud Drive Sync

- Multiple cloud account management like Google Drive, Dropbox, OneDrive, and hubiC
- Supports multiple cloud accounts
- Manual, scheduled, periodic and continuous sync
- Flexible file filtering using type, date, and size
- SSL transfer encryption
- Dashboard and job statistics
- Configurable network error recovery options
- Extensive job activity logging for tracing history of status and statistics
- Concurrent job execution and multi-threaded data transfer

- Per-account bandwidth throttling

Cloud Backup Station

- S3 Plus (including Amazon S3)
- Amazon Glacier
- Google Cloud Storage
- WebDAV-based cloud storage
- Microsoft Azure
- OpenStack Swift

Print Server

- Max number of printers: 3
- Supports Internet Printing Protocol
- Print job display and management
- IP-based and domain name-based privilege control

Photo Station

- Show photos by thumbnails, list, timeline, or folder view
- Supports virtual/smart albums
- Validity control for sharing albums
- Tag photos with text, colors, and ratings
- Slideshows with background music and different transition effects
- Geotag photos and display them on Google maps
- Supports uploading photos/videos to Picasa, Flickr, and Weibo
- Photo Station Extension: Supports face detection and PDF to image (available for x86-based models)
- Mobile app: Qphoto for online browsing and sharing

Music Station

- Play or share music via web browser
- Supports streaming music to multiple devices
- Supports changing album covers via Google search or by uploading photos
- Internet radio (MP3)
- Up to 8 music alarms
- Mobile app: Qmusic for music streaming and management
- Supports scrolling lyrics

iTunes Server

- Audio and video sharing for Windows® & Mac iTunes

Video Station

- Show photos by thumbnails, list, timeline, or folder view
- Supports virtual/smart collections
- Tag videos with text, color, and ratings
- Share video links to social websites or through email
- Display movie information and posters from Internet sources or user-uploaded files
- Supports displaying subtitles (*.SRT, *.ASS, *.SSA)
- Supports online searching and downloading of subtitles as well as importing subtitle files
- Supports adjusting the display style of subtitles
- Supports Facebook friends login
- Supports advanced folder permission settings
- Supports LDAP users
- Videos can be uploaded to YouTube and Youku
- Supports multi-zone video display
- Video seeking support for video playback during on-the-fly transcoding3
- Mobile app: Qvideo for online video browsing and management

AirPlay & Chromecast

- Streams videos, photos and music from NAS to Apple TV or Chromecast via File Station, Music Station, Photo Station, Video Station or mobile app (Qfile, Qmusic, Qphoto or Qvideo).

Note: The Media Streaming add-on app must be installed from the QTS App Center.

Download Station

- PC-less BT, FTP/FTPS, and HTTP/HTTPS, Thunder, FlashGet and qd4 download (up to 500 Tasks)
- The maximum number of concurrent downloads for an Intel/AMD x86-based NAS: 90 (30 BT/PT, 30 HTTP, 30FTP downloads)
- The maximum number of concurrent downloads for an ARM-based NAS: 30 (10 BT/PT, 10 HTTP, 10FTP downloads)
- BT download with search, Magnet Link and PT support
- Supports add-ons to expand download functionality
- Scheduled download and bandwidth control
- RSS subscription and download (broadcasting)
- Proxy support for BT download
- Mobile app: Qget for downloads browsing and management

Notes Station 3

- Collaborative editor for multi-user text editing
- Spreadsheet editor for creating tables
- Online quick preview of multimedia attachments
- Smart snapshot for version control

HD (HybridDesk) Station

- Use the NAS as a HTPC
- Enjoy videos, music, photos on TV via HDMI
- Web browsers (Chrome, Firefox)
- Supports international keyboards, input and mouse
- Supports user login permissions

Note:The playback and quality of some video files may be affected by the system's CPU and GPU decoding abilities.

Linux Station

- Support installing Ubuntu via Linux Station. Use your NAS as a Linux-based PC
- Download and use a variety of applications from the Ubuntu Software Center
- Supports remote desktop to monitor and access Ubuntu remotely

Virtualization Station

- Supports Virtual Machine (VM) creation to run operating systems such as Windows, Linux, Unix and Android
- Supports VM import and export
- Supports VM cloning & snapshots
- Supports VM backup and restore
- VM console can be displayed via HDMI output - QVM
- HTML5-based shared remote console
- Supports different networking modes via Virtual Switch

Container Station

- Supports LXC and Docker
- Download applications from the built-in Docker Hub Registry
- Supports one-click installation, container export/import & console mode

- Supports three networking modes (Bridge, NAT and Host)*
 - Supports auto-start containers
 - Supports downloading Docker certificates
 - Supports adding private registries
 - Added an application repository for users to switch to any repository on GitHub.com
- *Docker containers are capable of Bridge, NAT and Host mode, while Linux containers support NAT only.

Qsirch

- Supports full-text search
- Bar chart to show data distribution
- Supports previews for photos, music, videos, Gmail, PDF, etc.
- Support for using search operators in advanced search
- Search scope can be specified in advanced search
- Customized search filters
 - Users can include or exclude search conditions in Filter
 - Users can search files by filter conditions
- Added the ability to suggest related files in Viewer
- Supports cloud viewers for previewing document
- Show search results using thumbnails or a list
- Supports search Chrome extension

iSCSI (IP SAN)

- iSCSI target with multi-LUNs per target (Up to 256 targets/LUNs combined)
- Supports LUN mapping & masking
- Online LUN capacity expansion
- Support for SPC-3 persistent reservation
- Supports MPIO & MCS
- iSCSI LUN backup, one-time snapshot, and restoration
- iSCSI connection and management by QNAP Windows Qfinder
- Virtual disk drive (via iSCSI initiator)
- Stack chaining master
- Max No. of virtual disk drives: 8

Surveillance Station 5

- Supports over 3,000 IP cameras
- Includes 4 free camera licenses, up to 40 camera channels by purchasing additional licenses
- Instant playback to check recent events
- Visual aid by e-map
- Playback and speed control using the shuttle bar
- Video preview on playback timeline
- Intelligent video analytics (IVA) for advanced video searching
- Surveillance client for Mac
- Mobile surveillance app: Vmobile (iOS and Android)
- Mobile recording app: Vcam (iOS and Android)

QVPN Service (Integrated VPN Server, VPN Client and L2TP/IPSec VPN Services)

- VPN Server: Secure remote access with PPTP - L2TP/IPSec & OpenVPN VPN services
- VPN Server: Up to 100 clients
- VPN Server: Supports domain users as VPN users
- VPN Client: Supports PPTP, L2TP/IPSec & OpenVPN VPN protocols
- VPN Client: Supports importing .ovpn files to create OpenVPN connection

DLNA Server

- Supports DLNA/UPnP TVs and players such as PlayStation 4 and Xbox One
- Support CUE indexing file for APE, FLAC audio format.
- Video and Audio On-the-fly Transcoding3

Q'center (NAS CMS)

- Multiple NAS monitoring
- Utilization history reports
- Unified configuration management
- Visual display reports
- Monitor NAS behind NAT routers with Q'center Assistant
- Virtual appliances supported with Microsoft Hyper-V and VMware ESXi

OceanKTV

- Use the NAS as a karaoke machine
- Play videos from YouTube without needing to download them
- Display songs by artists, languages, and favorites
- Enhance the experience with effects such as tuning echo, key, or applause
- Control the playlist with a mobile app
- Supports keyboard and remote control (RM-IR002 or RM- IR004)

Note: Microphones are not included.

Qfinder Pro

- Find QNAP NAS that are on the same local network as your PC
- Easily mount NAS shared folders
- Configure basic settings for the NAS including firmware updates, setting SMTP server, and changing network settings
- Supports direct connection with USB QuickAccess
- Storage Plug & Connect (Windows only)
 - Create and map NAS shared folders
 - Create and connect to iSCSI target/LUNs
- Media Upload (Windows only)
 - Upload media files to the NAS and automatically create thumbnails or transcode videos using the PC

App Center

- Official and community software add-ons
- Automatically update apps or send notifications of new app versions
- App repository to import third-party content
- Choose what volume to save apps to

Qcontactz

- One-way scheduled sync of contacts from multiple Google accounts
- Import contacts from file: CSV or vCard 3.0
- Export contacts into a file: CSV and vCard 3.0
- Find duplicate contacts and merge them
- Snapshot management for your contacts database
- Manage contacts: Groups, favorite, lock, search, delete & restore
- Supported for mobile: Android and iPhone

Designs and specifications are subject to change without notice.

1. Not all IPv6 services are supported.
2. Data encryption functions may be unavailable in accordance with the legislative restrictions of some countries.
3. DRM-protected content is not supported.

Dual M.2 SSD expansion card

QM2 PCIe Card

Maximize NAS performance and connectivity



QM2-2S10G1T Dual M.2 2280 SATA SSD & single-port 10GbE expansion card
Connector: 2 x M.2 2280 SATA SSD slots; 1x 10GBASE-T port

QM2-2P10G1T Dual M.2 2280 PCIe SSD & single-port 10GbE expansion card
Connector: 2 x M.2 2280 PCIe SSD slots; 1x 10GBASE-T port

QM2-2S Dual M.2 22110/2280 SATA SSD expansion card
Connector: 2 x M.2 22110 or 2280 SATA SSD slots

QM2-2P Dual M.2 22110/2280 PCIe SSD expansion card
Connector: 2 x M.2 22110 or 2280 PCIe SSD slots



Q-tier



SSD cache



Self-monitoring



Cooling Module



10GbE / 10GBASE-T



M.2 SSD slots

QNAP SYSTEMS, INC.

TEL : +886-2-2641-2000 FAX: +886-2-2641-0555 Email: qnapsales@qnap.com

Address : 3F, No.22, Zhongxing Rd., Xizhi Dist., New Taipei City, 221, Taiwan

QNAP may make changes to specification and product descriptions at any time, without notice.

Copyright © 2017 QNAP Systems, Inc. All rights reserved.

QNAP® and other names of QNAP Products are proprietary marks or registered trademarks of QNAP Systems, Inc. Other products and company names mentioned herein are trademarks of their respective holders.

Netherlands (Warehouse Services)

Email: nlsales@qnap.com
TEL: +31(0)107600830

China

Email: cnsales@qnap.com
TEL: +86-400-028-0079

Thailand

Email: thsales@qnap.com
TEL: +66-2-5415988

Japan

Email: jpsales@qnap.com
FAX: 03-6435-9686

US

Email: usasales@qnap.com
TEL: +1-909-595-2782

India

Email: indiasales@qnap.com

Germany

Email: desales@qnap.com

France

Email: frsales@qnap.com



51000-024293-RS
201707 (EN) A