

Installation and user manual

5SC 500i
5SC 750i
5SC 1000i
5SC 1500i

Copyright © 2013 **EATON**
All rights reserved.

Service and support:
Call your local service representative

619-00470-01-i (en)

Certification Standards

UPS directives:

- Safety: IEC 62040-1: 2008
- EMC: IEC 62040-2: 2005
- Performance: IEC 62040-3: 2010

CE mark (EN 62040-1: 2008 and EN 62040-2: 2006 (C1))

Class B emission level CISPR 22: 2005 + A2 2006 (EN 55022)

Harmonics emission: IEC 61000-3-2 edition 3.2: 2009

Flickers emission: IEC 61000-3-3 edition 2: 2008

The EC Declaration of Conformity is available upon request for products with a CE mark.

For copies of the EC Declaration of Conformity, contact Eaton Power Quality or check Eaton website: www.powerquality.eaton.com

Special Symbols

The following are examples of symbols used on the UPS or accessories to alert you to important information:



RISK OF ELECTRIC SHOCK - Observe the warning associated with the risk of electric shock symbol.



Important instructions that must always be followed.



Do not discard the UPS or the UPS batteries in the trash.
This product contains sealed lead acid batteries and must be disposed as it's explain in this manual.
For more information, contact your local recycling/reuse or hazardous waste center.



This symbol indicates that you should not discard waste electrical or electronic equipment (WEEE) in the trash. For proper disposal, contact your local recycling/reuse or hazardous waste center.



Information, advice, help.

1. Introduction.....	4
1.1 Environmental protection	4
2. Presentation	5
2.1 Standard installation	5
2.2 Rear panels	5
2.3 Control panel	6
2.4 LCD description	6
2.5 UPS setting through the LCD	6
3. Installation	7
3.1 Unpacking and contents check.....	7
3.2 Communication ports	8
4. Operation.....	9
4.1 Start-up and Normal operation.....	9
4.2 Starting the UPS on Battery	9
4.3 UPS Shutdown	9
4.4 Operation on Battery Power	9
4.5 Return of AC Input Power.....	9
5. Maintenance	10
5.1 Troubleshooting.....	10
5.2 Battery-module replacement	11
6. Appendices	12
6.1 Technical specifications.....	12

1. Introduction

Thank you for selecting an EATON product to protect your electrical equipment.

The 5SC range has been designed with the utmost care.

We recommend that you take the time to read this manual to take full advantage of the many features of your UPS (Uninterruptible Power System).

Before installing 5SC, please read the booklet presenting the safety instructions. Then follow the instructions in this manual.

To discover the entire range of EATON products and the options available for the 5SC range, we invite you to visit our web site at www.eaton.com/powerquality or contact your EATON representative.

1.1 Environmental protection

EATON has implemented an environmental-protection policy. Products are developed according to an eco-design approach.

Substances

This product does not contain CFCs, HCFCs or asbestos.

Packing

To improve waste treatment and facilitate recycling, separate the various packing components.

- The cardboard we use comprises over 50 % of recycled cardboard.
- Sacks and bags are made of polyethylene.
- Packing materials are recyclable and bear the appropriate identification symbol 

Materials	Abbreviations	Number in the symbols 
Polyethylene terephthalat	PET	01
High-density polyethylene	HDPE	02
Polyvinyl chloride	PVC	03
Low-density polyethylene	LDPE	04
Polypropylene	PP	05
Polystyrene	PS	06

Follow all local regulations for the disposal of packing materials.

End of life

EATON will process products at the end of their service life in compliance with local regulations. EATON works with companies in charge of collecting and eliminating our products at the end of their service life.

Product

The product is made up of recyclable materials.

Dismantling and destruction must take place in compliance with all local regulations concerning waste. At the end of its service life, the product must be transported to a processing centre for electrical and electronic waste.

Battery

The product contains lead-acid batteries that must be processed according to applicable local regulations concerning batteries.

The battery may be removed to comply with regulations and in view of correct disposal.

2.1 Standard installation

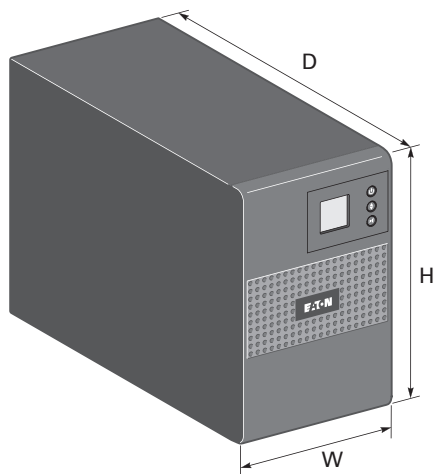

Description	Weights (kg/lb)	Dimensions (mm/inch) D x W x H
5SC 500i	6.60 / 14.60	240 x 150 x 210 / 9.4 x 5.9 x 8.3
5SC 750i	10.40 / 22.90	340 x 150 x 210 / 13.4 x 5.9 x 8.3
5SC 1000i	11.10 / 24.50	340 x 150 x 210 / 13.4 x 5.9 x 8.3
5SC 1500i	15.20 / 33.50	410 x 150 x 210 / 16.1 x 5.9 x 8.3

2.2 Rear panels

5SC 500i

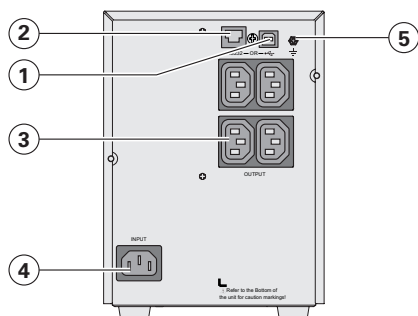

5SC 750i

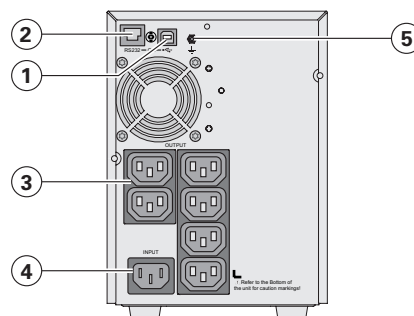

5SC 1000i

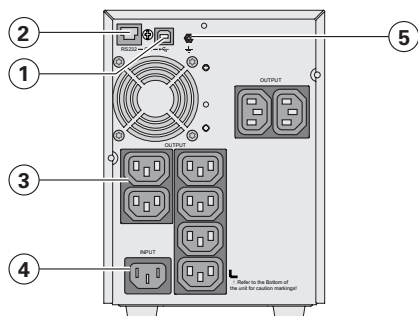

5SC 1500i

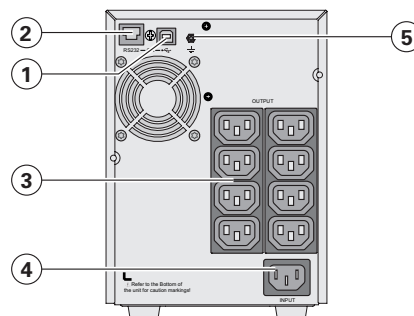

- (1) USB communication port
- (2) RS232 communication port
- (3) Outlets for connection of critical equipment
- (4) Socket for connection to AC-power source
- (5) Ground screw

2. Presentation

2.3 Control panel

The UPS has a three-button LCD. It provides useful information about the UPS itself, load status, events, measurements and settings.

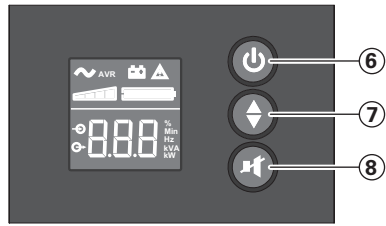

- ⑥ ON/OFF button
- ⑦ Scroll down
- ⑧ Mute alarm

2.4 LCD description

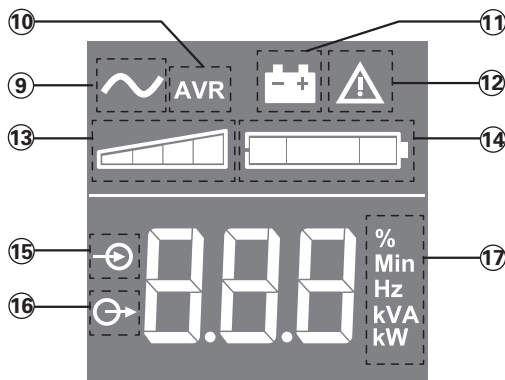

- ⑨ UPS ON
- ⑩ AVR mode
- ⑪ Battery mode
- ⑫ Internal fault
- ⑬ Output load level
- ⑭ Battery level
- ⑮ Input measurements
- ⑯ Output measurements
- ⑰ Measuring unit

2.5 UPS setting through the LCD

Release scroll down button to select menu

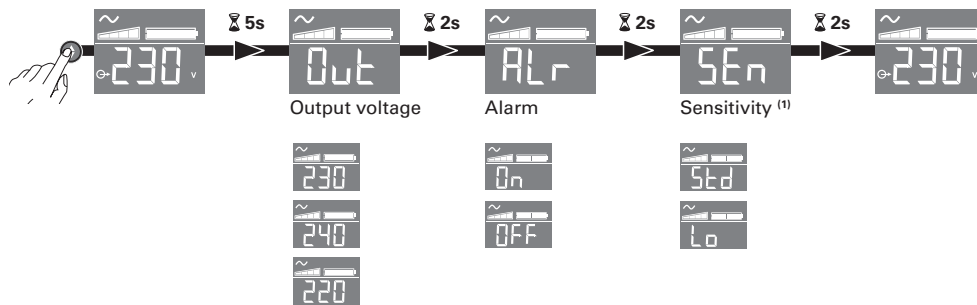

Example of setting

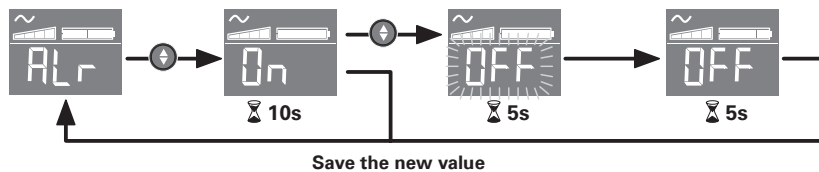

- LCD will shut off if there is no activity for 3 minutes.

(1) In low sensitivity mode (Lo) UPS will tolerate more fluctuations in power and will go on battery power less often. If the connected load is sensitive to power disturbances, keep the sensitivity as Standard (Std).

3.1 Unpacking and contents check

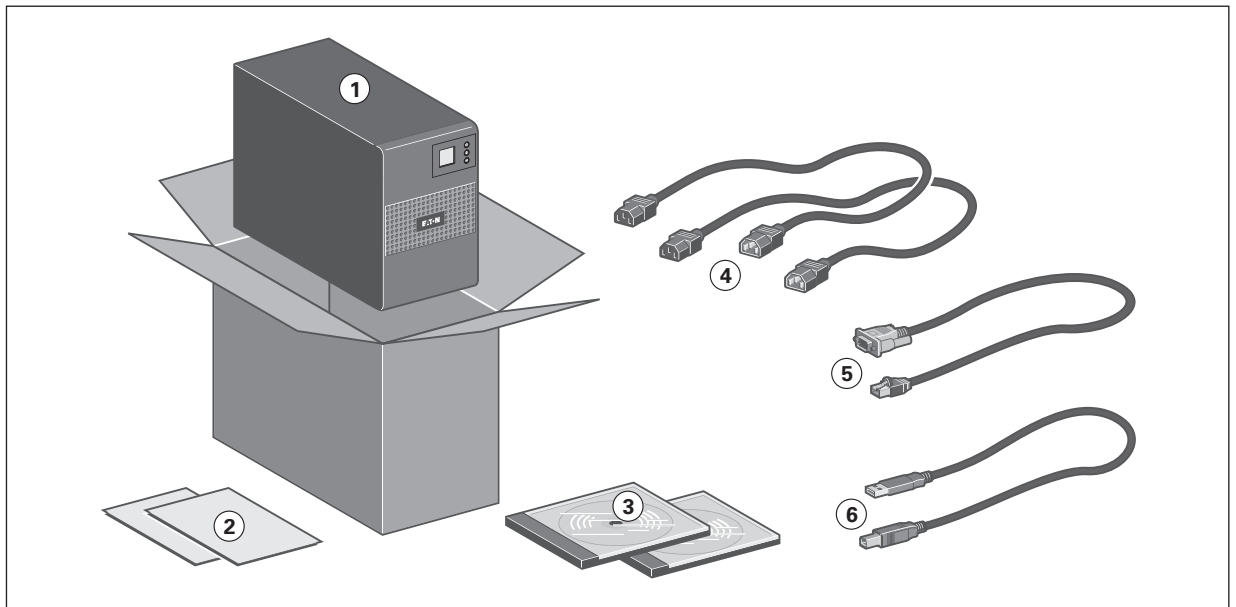

- (1) 5SC UPS
- (2) Quick start and safety instructions
- (3) User manual and IPSS (Intelligent Power Software Suite) CDROM
- (4) 2 connection cables for the protected equipment
- (5) RS232 communication cable
- (6) USB communication cable



Packing materials must be disposed of in compliance with all local regulations concerning waste. Recycling symbols are printed on the packing materials to facilitate sorting.

3. Installation

3.2 Communication ports

Connection of RS232 or USB communication port

The RS232 and USB communication ports cannot operate simultaneously.

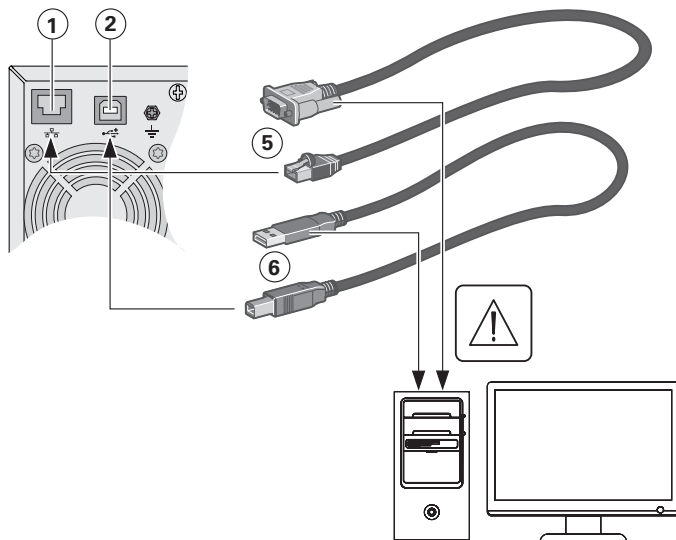

1. Connect the RS232 (5) or USB (6) communication cable to the serial or USB port on the computer equipment.
2. Connect the other end of the communication cable (5) or (6) to the USB (1) or RS232 (2) communication port on the UPS.

The **UPS** can now communicate with EATON power management software.

Characteristics of the optocoupler RS232 communications port

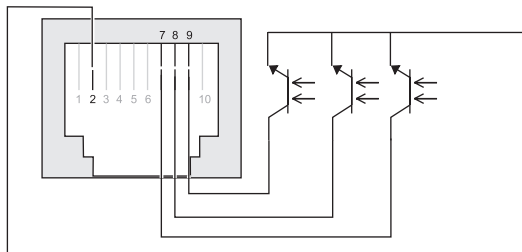

- Pins 1, 3, 4, 5, 6, 10: not used
- Pin 2: common (user)
- Pin 7: low battery
- Pin 8: operation on battery power
- Pin 9: UPS ON, equipment supplied

n.o.: normally open contact



When a signal is activated, the contact is closed between the common (pin 2) and the pin for the corresponding signal.

Contact characteristics (optocoupler)

- Voltage: 48 V DC max
- Current: 25 mA max
- Power: 1.2 W

4.1 Start-up and Normal operation

To start the UPS:



1. Verify that the UPS power cord is plugged in.
2. Press the  button on the UPS front panel for at least 2 seconds.
3. Check the UPS front panel display for active alarms.
If the  indicator is on, do not proceed until all alarms are cleared.
Correct the alarms and restart if necessary.
4. Verify that the  indicator illuminates solid, indicating that the UPS is operating normally and any loads are powered and protected.

4.2 Starting the UPS on Battery





Before using this feature, the UPS must have been powered by utility power with output enabled at least once.

To start the UPS on battery:

1. Press the  button on the UPS front panel until the UPS front panel display illuminates.
The UPS cycles through Standby mode to Battery mode. The  indicator illuminates solid.
The UPS supplies power to your equipment.
2. Check the UPS front panel display for active alarms. Resolve any active alarms before continuing.
See "Troubleshooting" on page 10.

4.3 UPS Shutdown

To shut down the UPS:

1. Press the  button on the front panel for three seconds.
The UPS starts to beep. The UPS then transfers to Standby mode, and the  indicator turns off.

4.4 Operation on Battery Power

Transfer to battery power

- The connected devices continue to be supplied by the UPS when AC input power is no longer available. The necessary energy is provided by the battery.
- The  indicator illuminates solid.
- The audio alarm beeps every ten seconds.



The connected devices are supplied by the battery.

Low-battery warning

- The  indicator illuminates solid.
- The audio alarm beeps every three seconds.



The remaining battery power is low. Shut down all applications on the connected equipment because automatic UPS shutdown is imminent.

End of battery backup time

- All the LEDs go OFF.
- The audio alarms stops.

4.5 Return of AC Input Power

Following an outage, the UPS restarts automatically when AC input power returns (unless the restart function has been disabled) and the load is supplied again.

5. Maintenance

5.1 Troubleshooting

Operation status	Possible cause	Action
Overload OL	Power requirement exceeds the UPS capacity (greater than 105 % of nominal).	Remove some of the equipment from the UPS. The UPS continues to operate, but may shutdown if the load increases. The alarm resets when the condition becomes inactive.
Short-circuit fault SC	A short-circuit occurred.	Check device connection or integrity. If error persists, note the alarm message and the UPS serial number, and then contact your service representative.
Battery fault BAT	The batteries in the UPS are disconnected.	Verify that all batteries are properly connected. If error persists, note the alarm message and the UPS serial number, and then contact your service representative.
	The end of battery life is reached.	Contact your service representative for battery replacement.
Fan fault FAn	The UPS has a fan fault.	Check that no object is blocking the fan. If error persists, note the alarm message and the UPS serial number, and then contact your service representative.
Charger fault Chr	The UPS has a charger fault.	The UPS does not charge the battery anymore. Note the alarm message and the UPS serial number, and then contact your service representative.

5.2 Battery-module replacement

Safety recommendations

The battery can cause electrocution and high short-circuit currents. The following safety precautions are required before servicing the battery components:

- remove watches, rings, bracelets and all other metal objects from the hands and arms,
- use tools with an insulated handle.

Battery tray removal on tower models

This operation must be performed when the UPS is switched OFF, and unplugged from AC source.

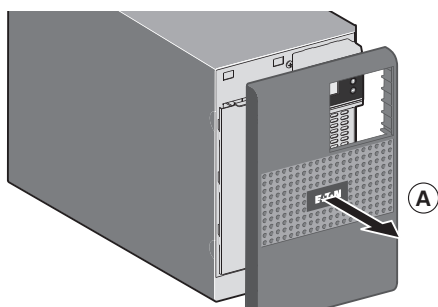

A - Remove the front panel.

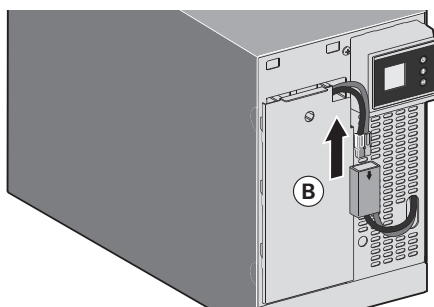

B - Disconnect the battery block by separating the two connectors (never pull on the wires).

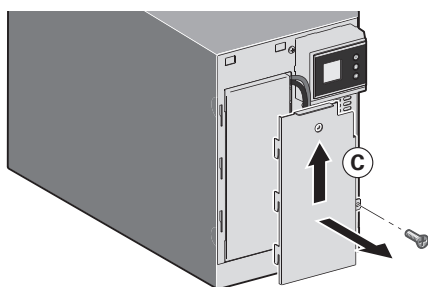

C - Remove the plastic protection cover in front of the battery (one screw).

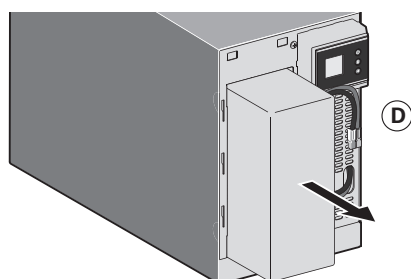

D - Pull the plastic tab to remove the battery block and replace it.

Mounting the new battery module

Carry out the above instructions in reverse order.



- To ensure safety and high performance, use only batteries supplied by EATON.
- Take care to firmly press together the two parts of the connector during remounting.

6. Appendices

6.1 Technical specifications

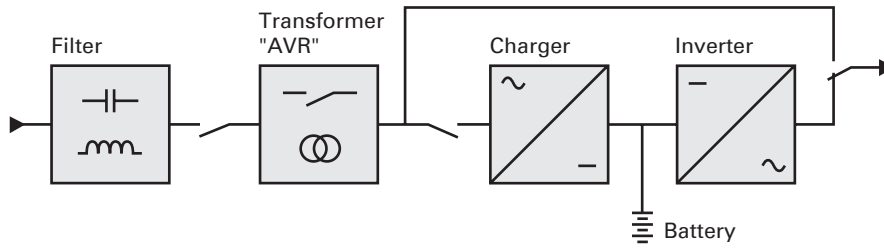

	5SC 500i	5SC 750i	5SC 1000i	5SC 1500i
Output Power @ 230 V	500 VA 350 W	750 VA 525 W	1000 VA 700 W	1500 VA 1050 W
AC Input power				
• Rated input voltage	Single phase 220-240 V			
• Input voltage range	184 to 276 V			
• Input frequency range	45 to 55 Hz (50 Hz system), 55 to 65 Hz (60 Hz system)			
Output on battery power				
• Voltage	220/230/240 V (-10/+6 %) ⁽¹⁾			
• Frequency	50/60 Hz ±0.1 Hz			
Battery (sealed lead acid, maintenance free)				
• Standard	1 x 12 V 9 Ah	2 x 12 V 7 Ah	2 x 12 V 9 Ah	3 x 12 V 9 Ah
Environment				
• Operating temperature range	0 to 35 °C / 32 to 95 °F			
• Storage temperature range	-15 to +40 °C / 5 to 104 °F			
• Relative humidity	0 to 90 % (without condensation)			
• Noise level	< 40 dBA in normal mode			

(1) Adjustable to 220/230/240 V, must be set to the identical AC power source value.

When the appliance is used in EU area, use an external circuit breaker in front of line with rating 16 A, 250 V which is IEC/EN 60898-1 standard compliant;

When the appliance is used in America area, use an external circuit breaker in front of line with rating 20 A, 250 V.

This product is designed for IT power distribution system.